



RADIO'S LIVEST MAGAZINE

Special  
RADIO—  
EXPERIMENTER  
Number

# Radio-Craft

December

25 Cents

Canada 30c

HUGO GERNSBACK Editor



See Page 334

Novel Circuit Ideas—Servicing Theatre "Talkies"—Simple "Lie" Detector  
"Mr. X", A Radio Robot—Novel 1-Tube Superhet.—"Junk Box" Coil Winder

**Supreme Instruments Corp., Greenwood, Miss., U. S. A.**

Export Dept., Associated Exporters Co., 145 West 45th St., New York City, N. Y. Cable Address, LOPREH, N. Y.

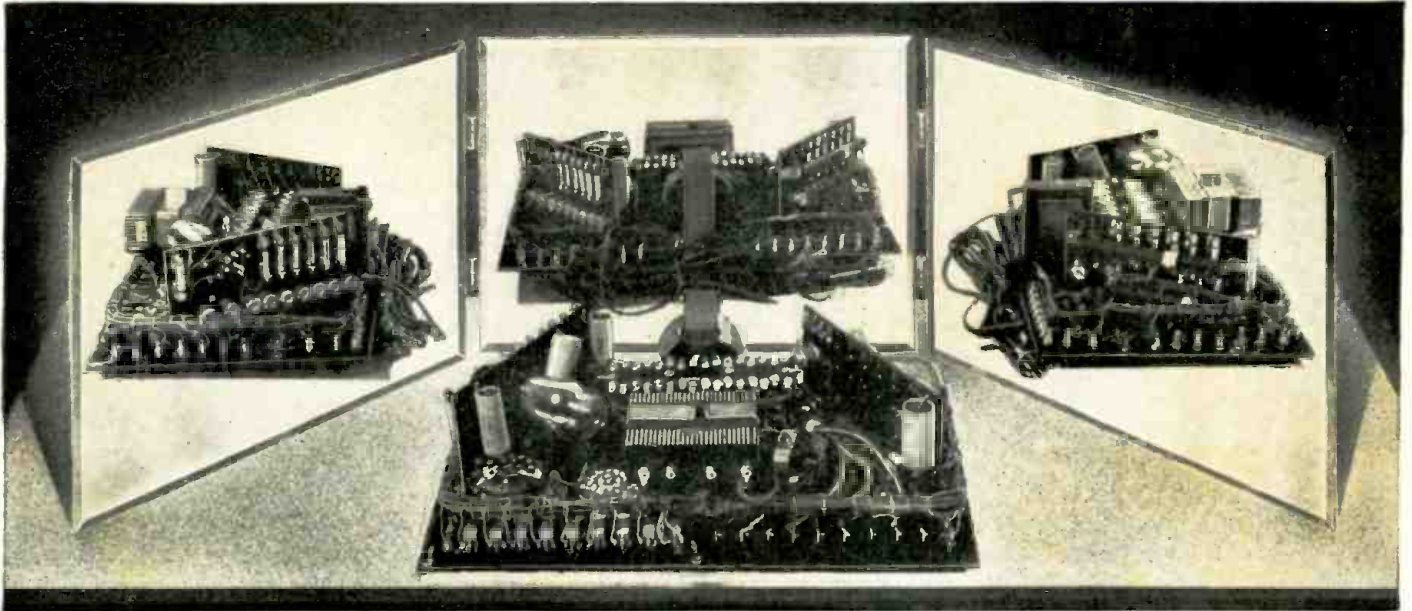

From All Angles . . . Inside or Out . . .

• Superb Engineering • Quality • Appearance

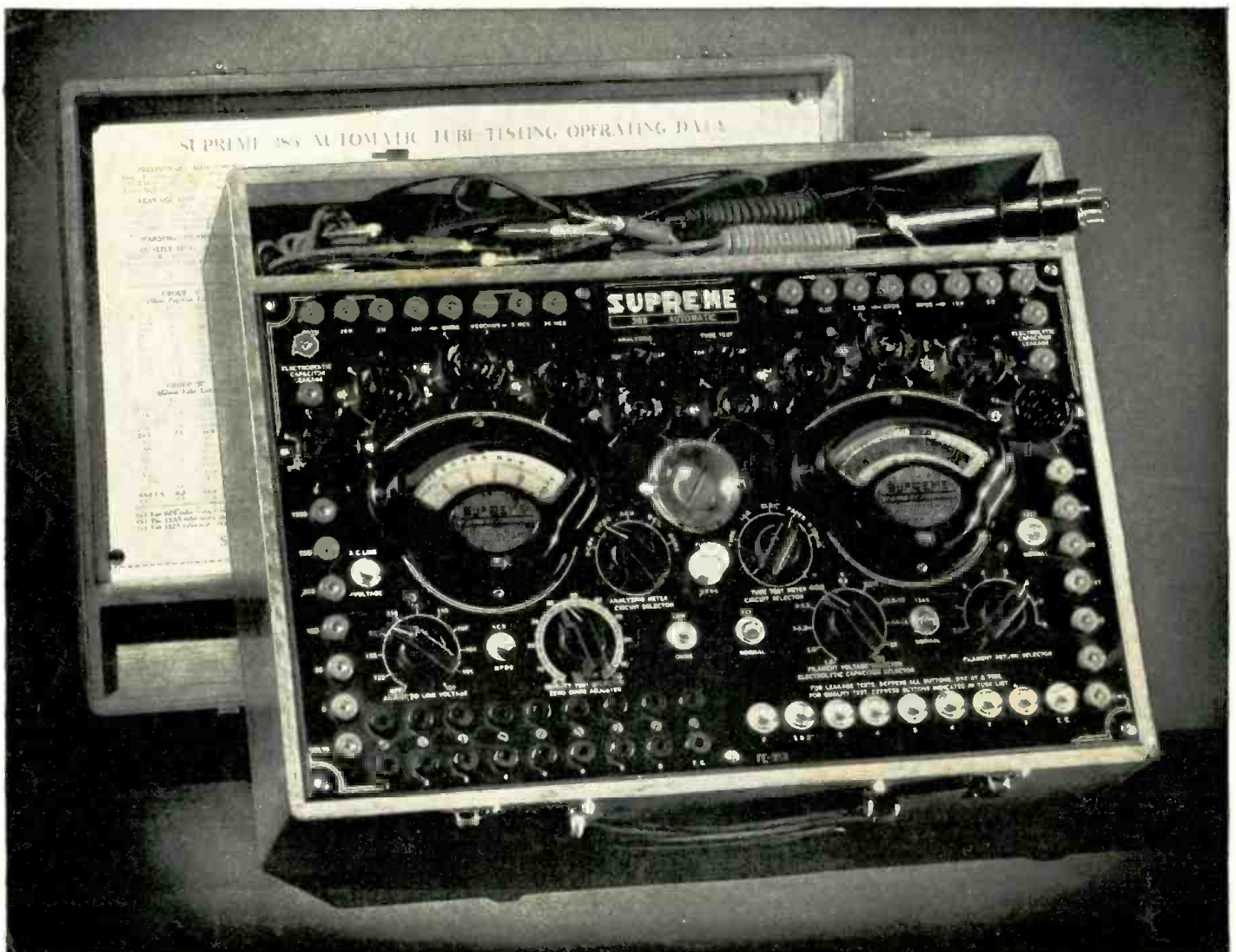

Write For Catalog • See Your Jobber



STUDENTS BUSY AT WORK IN LARGE COYNE SHOPS

# Learn RADIO

**SEND TODAY FOR DETAILS OF MY Pay-Tuition-after-Graduation Plan!**

Train for Radio in 90 days, right here in the big Coyne Shops — not by correspondence — but on real Radio, Sound and Television equipment. Mail the coupon below. If you are short of money I'll send you all details of my finance plan and consider your application. If accepted, you won't have to start paying tuition back until five months from the date you start school, and then you'll have over a year to complete your payments.

## Tremendous Developments Ahead in Radio and Television!

HERE is YOUR opportunity to cash in. Every day brings news of new developments in every branch of Radio and Television, with more opportunities, more jobs, and a greater future for the trained man than ever before. I consider the fellow who is ambitious enough to want to get ahead by taking my Training, worthy of my help. MAIL THE COUPON BELOW and you can prove to me that you are willing to spend just 12 weeks in the Coyne Training Shops learning Radio. Then, I'll tell you about my finance plan which has enabled many to get complete Training and pay tuition back later.

## Learn By Doing In 90 Days

I don't care whether you are 16 or 45. It makes no difference to me if you don't know an oscillator from a spark coil. You don't need any previous experience or advanced education to master my Shop Training. Don't let lack of money hold you back from getting all details of my amazing plan.

### MANY EARN While LEARNING

If you need part-time work to help pay your living expenses and will tell us your problems we may be able to help you as we have thousands of others. Then, in 12 brief weeks, in the great Training shops of Coyne, you will learn on a wide variety of modern, up-to-date A. C. Superheterodyne sets, oscillators, analyzers and test instruments. Prepare for Amateur Broadcast, or Telegraph Radio Operator's License and to know all code and Dept. of Commerce rules for government License Examination.

### TRAINING

#### By Actual Work

No dull books . . . you get individual training . . . real actual work with only the theory you will need. Building real radio sets,



### Auto Radio Instruction Prepare For Jobs Like These

Here are a few of hundreds of positions in the Radio field. My free employment bureau gives you life-time employment service.

- AIRCRAFT RADIO OPERATOR
- SHIP RADIO OPERATOR
- RADIO SERVICING
- PUBLIC ADDRESS SYSTEMS
- BROADCAST STATION OPERATOR
- TALKING PICTURE STUDIOS
- TELEVISION LABORATORY MAN

doing radio wiring and testing, trouble-shooting, repairing and servicing. That's a glimpse of how we help to make you a Radio expert, and fit you to qualify for jobs leading to the biggest pay.

### Jobs • Pay • Future

"I got my present job two days after graduation, at shorter hours, and wages increased 60% over my old job," reports Arne Wiklem of Minnesota. "I have my own shop, own a real car and make fine money in the radio business," writes E. Allen of Montana, "All this is possible because I came to Coyne." And I could go on quoting from hundreds of letters of successful Coyne Trained men. What they have done, you should be able to do.

### Electric Refrigeration Air Conditioning

Right now I'm including my new Electric Refrigeration and Air Conditioning course at no extra cost.

### GET THE FACTS

Coyne is your one great chance to get into Radio. This school is 36 years old—Coyne training is tested—proven beyond all doubt—endorsed by many large concerns. You can find out everything absolutely free. Simply mail the coupon and let me send you the big, free Coyne Book with photographs . . . facts . . . jobs . . . salaries . . . opportunities. Tells you how many earn expenses while training and how we assist our graduates in the field. This does not obligate you. So act at once.

**MAIL Coupon Today for FREE BOOK!**



*H. C. Lewis*



### Home of Coyne Shops

This is our fireproof modern Building wherein is installed thousands of dollars' worth of Radio equipment of all kinds. Every comfort and convenience has been arranged to make you happy and contented during your Training.

**H. C. LEWIS, President Coyne Radio & Electrical School 500 S. Paulina St. Dept. 95-8H Chicago**

Dear Mr. Lewis: Without obligation send me your big free catalog and all details; also tell me all about your "Pay-Tuition-After-Graduation" Plan.

Name.....Age.....  
 Address.....  
 City.....State.....

**COYNE** H. C. LEWIS, President **Founded 1899**  
**RADIO & ELECTRICAL SCHOOL**  
 500 South Paulina Street Dept. 95-8H **Chicago, Ill.**

Please Say That You Saw It in RADIO-CRAFT



# CONTENTS—DEC., 1935, ISSUE

Volume VII Number 6

ORSMA Members' Forum.....	324
Editorial: Radio Experimenting.....Hugo Gernsback	325
The Radio Month in Review.....	326
What Prominent Radio Men Say About the Home Laboratory.....	328
Radio Pictorial.....	329
International Radio Review.....	330
Useful Circuit Ideas.....	331
The Listening Post for All-Wave DX-ers..C. A. Morrison	332
New Metal Cores for R.F. Coils.....Henry L. Crowley	333
Television in the Theatre, Part II Alfred N. Goldsmith	333
The Experimenter's Laboratory.....C. W. Palmer	334
A Simple "Radio" Lie Detector.....Wm. Hillegas	335
A 5-In-3 S.-W. Experimenter's Set.....Guy Stokely	335
At the New York Radio Show.....	336
An Experimenter's I-Tube Double-Regenerative Superhet.....R. D. Washburne	337
Making "Mr. X"—A Radio Robot.....Ted Muralt	338
An Improved Booster for S.-W. and All-Wave Sets....H. B. Russ	339
Interpreting Cathode-Ray Resonance Curves.....Alfred A. Ghirardi	339
A 10-Tube Short-Wave Amateur Superhet.....McMurdo Silver	340
How to Make Higher Fidelity Recordings on Aluminum.....E. A. Dennis	340
How to Make a Simple Coil Winder.....Paul Rosekrans	341
Servicing Theatre Sound Systems, Part I.....A. V. Ditty	342
Electronics Aids "Behaviorism" Tests.....Ormal I. Sprungman	343
How to Equip A Sound Truck for Electioneering, etc., Part II.....Charles R. Shaw	343
The Photo-cell in the Experimenter's Lab.....	344
Announcing the Winners in <i>Radio-Craft's</i> "Ideal Radio Service Shop" Contest.....	345
80 Features in the New 18-Metal-Tube Set!.....W. A. Smith	345
How to Make a Sensitive Relay Unit.....E. L. Deeter	346
How to Add High Fidelity to Old Sets.....Wilhelm E. Schrage	347
A Precision Bridge-Type Condenser Analyzer.....S. A. Wolin	348
How the 6E5 Cathode-Ray Tuning Tube Works.....	348
Short-Cuts in Radio.....	349
The Latest Radio Equipment.....	350
<b>RADIO SERVICE DATA SHEETS:</b>	
No. 151—Wells-Gardner 5E Series Chassis (Model 25E1 to 25E5 Sets) 5-Tube Battery Superhet.; Echo-phone Model C 6-Tube A.C. Broadcast Band Mantel Set.....	352
No. 152—American-Bosch Model 595 10-Tube All-Wave Superheterodyne.....	353
Operating Notes.....	354
Technicians' Data Service.....	361
Book Review.....	382

HUGO GERNSBACK, Editor-in-Chief  
 C. W. PALMER Associate Editor  
 H. G. McENTEE Associate Editor  
 R. D. WASHBURNE, Technical Editor

## NEW SHORT-WAVE NUMBER

With the January, 1935 issue of *Radio-Craft* we introduced, as the first of a series of feature issues, a special SHORT-WAVE NUMBER in which more than two-dozen technical and non-technical developments were described. Again, one year later, we will present the 1936 feature SHORT-WAVE NUMBER of *Radio-Craft*, bringing the radio man up-to-date on short-wave technique.

Ultra-short-wave television, an automobile-type 5-meter transmitting and receiving station, all-wave radio sets, service data and procedure for all-wave receivers, and other interesting developments will be described in detail. The service articles and the practical construction data given in this *new series* issue, include not only short waves but also subjects in allied branches of radio.

This special SHORT-WAVE NUMBER of *Radio-Craft* is due on the newsstand *about the first of December*. Be sure that your newsdealer orders a copy for you.

RADIO-CRAFT is published monthly, on the first of the month preceding that of date; its subscription price is \$2.50 per year. (In Canada and foreign countries, \$3.00 a year to cover additional postage.) Entered at the post office at Mount Morris, Ill., as second-class matter under the act of March 3, 1879.

Text and illustrations of this magazine are copyright and must not be reproduced without permission of the copyright owners. We are also agents for WONDER STORIES and EVERYDAY SCIENCE AND MECHANICS. Subscription to these magazines may be taken in combination with RADIO-CRAFT at reduced Club rates. Write for information.

Copyright 1935. Continental Publications, Inc.

HUGO GERNSBACK, President I. S. MANHEIMER, Secretary

Published by Continental Publications, Inc. Publication office: 404 N. Wesley Ave., Mount Morris, Illinois. Editorial and Advertising Office: 99 Hudson Street, New York City. Chicago Advertising Office: L. F. McClure, 919 North Michigan Avenue, Chicago, Ill. Western Advertising Office: Loyd B. Chappell, 511 So. Alexandria St., Los Angeles, Calif.

### European Agents:

London—Gorrings' American News Agency, 9A Green St., Leicester Square, London, W. C. 2.

Paris—Messageries Dawson, 4 Rue Faubourg, Poissonniere, Paris, France.

Australian Agent: McGill's Agency, 179 Elizabeth St., Melbourne.

# NEW Power Output TUBE TESTER

OTHER NEW MODELS

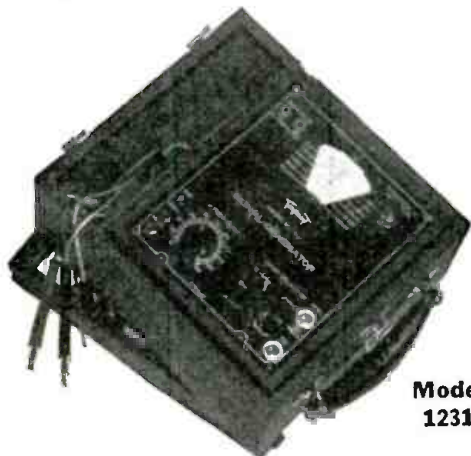

Model 1231

ALL WAVE DIRECT READING SIGNAL GENERATOR. All frequencies fundamentals, stabilized 100-30,000 KC. Jacks for 400 cycle audio note. Very accurate yet easy to operate. Model 1231 complete with batteries and two No. 30 tubes. Dealer net price.....\$26.67  
Model 1232 same except uses 110-60 cycle A.C. Dealer net price.....\$26.67  
Carrying Case Shown—Dealer net Price..... 4.00



**10**  
**INSTRUMENTS**  
**IN ONE**

PRECISION WITHOUT  
EXTRAVAGANCE

Model 1501 \$46<sup>67</sup>  
Dealer's Net

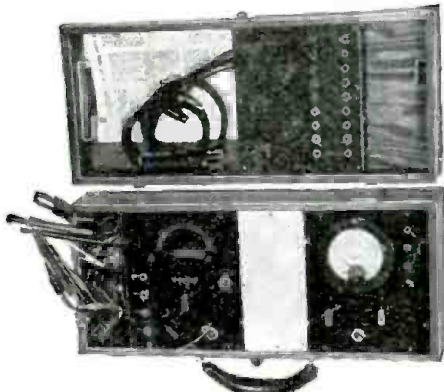

FREE POINT TEST SET Model 1181-A combines three essential units: No. 1125 Volt-Ohm-Milliammeter, 1151 All Wave Oscillator, 1166-A Free Point Auxiliary Set Tester—units can be purchased separately if desired. Dealer net price...\$38.00



MASTER UNIT COMPLETE Model 1206—A complete, up-to-date laboratory contains Nos. 1200 Volt-Ohm-Milliammeter, 1210-A Tube Tester, 1220-A Free Point Tester, 1231 or 1232 All-Wave Signal Generator and No. 1204 Case. All items can also be purchased separately and complete unit built up over period of time. Dealer net price.....\$82.67

THE NEW MULTI PURPOSE TUBE TESTER MODEL 1501—Radio service dealers have always wanted a tube tester that would test tubes under conditions approximating their use in a radio set. Here it is! Model 1501 combines in one unit ten instruments that are needed by radio servicemen in their daily work. Here are the ten instruments:

1. Test all type tubes (New Power Output Test).
2. Neon short test.
3. Separate Diode Tests.
4. Neon Paper Condenser Tests.
5. Electrolytic Condenser Leakage.
6. D. C. Voltmeter and Milliammeter.
7. Ohmmeter.
8. A. C. Voltmeter.
9. Decibel Meter.
10. Impedance Meter.

TESTS ALL TYPES—old style, new style, both metal and glass-metal—specially constructed against obsolescence.

Bring on your trick tubes that get by other testers—try them in TRIPLETT'S new Power Output Tester—see for yourself how this instrument can save you time in hunting for troubles and help you to sell more tubes. Each tube is measured by output test, that is, the tube is fully loaded and does not have an opportunity to reheat for an instantaneous test. It will definitely help you sell more tubes by finding more bad and weak ones.

Model 1500 is a power output tube tester with neon short test and shadow-graph line voltage indicator. Same case as Model 1501. Dealer net price \$36.67

THE TRIPLETT ELECTRICAL INSTRUMENT CO.  
BLUFFTON, OHIO



**TRIPLETT MANUFACTURES**  
a complete line of electrical instruments for radio, electrical and general industrial purposes — both standard and custom built. Write for Catalogue. See your jobber

Please Say That You Saw It in RADIO-CRAFT



A department devoted to members and those interested in the Official Radio Service Men's Association. It is the medium for exchanging ideas, kinks, gossip and notes of interest to Service Men, or others interested in servicing.

## ECONOMICAL AMPLIFIER

RADIO-CRAFT, ORSMA Department:

The diagram, Fig. 1, shows the revamped circuit of an amplifier re-built from the parts in the A.F. section of an old Kennedy No. 26 set, which used 1-80, 2-45s, 4-24s, and 1-27. Only a few parts need be added, and the result is a high-quality unit.

The 2.5 V. heater winding was connected to the sockets which now feed the 2B6s, while the 2.5 V. filament winding supplies the type 57 and 56 tubes; both windings are unloaded. A 5Z3 replaces the old 80 rectifier.

Extra parts required for the 2B6 tubes are:

- One 10 W., 300-ohm resistor;
- Two 1 W., 8,000-ohm resistors;
- Two large 7-pin sockets.

A large "universal" type output transformer is used to connect the original speaker voice coil, and also an additional A.C. dynamic voice coil.

All the grid leads are shielded, as are the 57 and 56 tubes, and the hum level is very low.

CLIFFORD COLLINS,  
Highland, Ill.

## A COMPLETE SHOP

RADIO-CRAFT, ORSMA Department:

Enclosed you will find a photograph of my service shop work bench. As you will see, the shop is equipped to service radio sets and also sound and talking picture equipment. I also made some theatre sound installations. At the left of the photograph you will see a regulation theatre sound turntable, and also a moving picture tube.

I hope this picture will be suitable for use in your magazine.

ALFRED L. LEPORE,  
Providence, R.I.

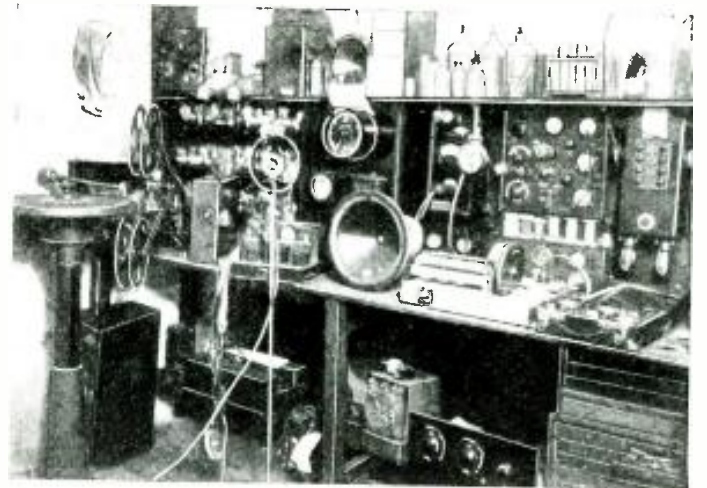

Fig. 2. A complete shop equipped to service sound apparatus and radio sets.

one may obtain Canadian radio service data.

The reason is that I have received several letters in which my honorable fellow Canadian radio Service Men did not express themselves in the best of terms. In fact one of them wanted to know what kind of a racket it was, so dear Editor, they will have to find out for themselves.

ROBERT ROGERS,  
Arundel, Quebec

It is to be regretted that some few always abuse a privilege, and so spoil an opportunity for the others.

## A PLEA

RADIO-CRAFT, ORSMA Department:

May I ask you to please send me two application blanks of the ORSMA.

Here is one thing I would like to ask you: For the protection of the radio service profession, is there anything the ORSMA could do to shut out the greenhorns who are just dabbling at this art and don't know a thing about it, yet are actually damaging the profession? What I mean is, to make this a branch

(Continued on page 356)

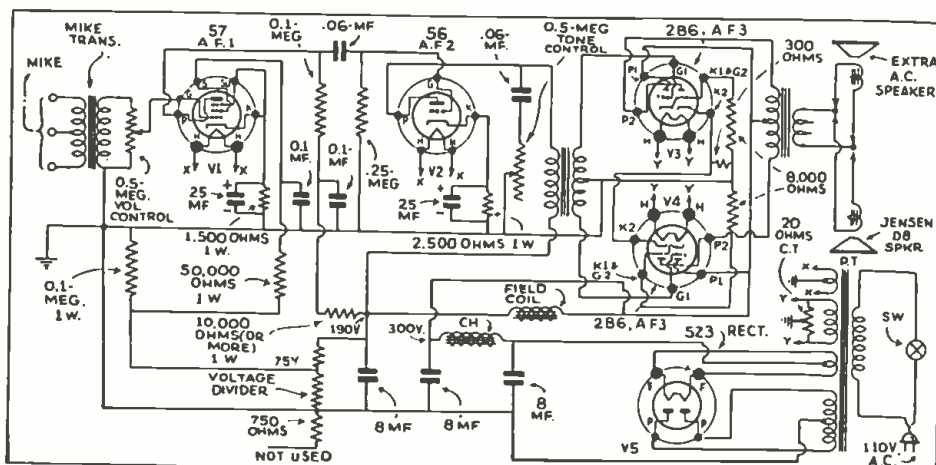

Fig. 1. An efficient amplifier made at very low cost from a discarded set. The output is high and quality is very good.

The picture is certainly suitable, and we are pleased to be able to show members a shop equipped to handle theatre sound service work.

## THEIR LOSS

RADIO-CRAFT,  
ORSMA Department:

In regard to my letter as published in a recent issue of *Radio-Craft*, will you please inform your Canadian readers that I cannot answer any more letters inquiring as to where



J. E. SMITH, Pres. National Radio Institute

# I WILL TRAIN YOU AT HOME

## IN SPARE TIME FOR A

# GOOD RADIO JOB!

### FREE BOOK TELLS HOW MAIL COUPON

Act today for better pay. Act to break away from a low-pay, no-future job. To get away from having to skimp, scrape to pay your bills. Mail coupon for my free 64-page book. It tells you how I will train you at home in your spare time to be a Radio Expert; about my training that has helped hundreds of men to make more money.

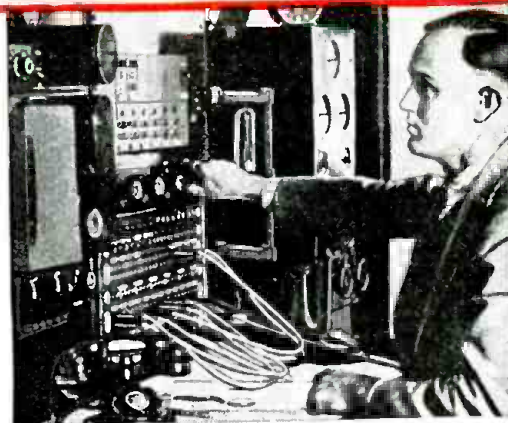

### SAVE MONEY—LEARN AT HOME

My Special Equipment Gives You Broad Practical Experience

Hold your job. No need to leave home and spend a lot of money to become a Radio Expert. I'll train you quickly and inexpensively right at home in your spare time. You don't need a high school or college education. Many of my successful graduates didn't finish grade school. My practical 50-50 method of training—half with lessons, half with Radio equipment—I furnish—gives you broad practical experience—makes learning at home easy, fascinating, practical and quick. There is opportunity for you in Radio. Old jobs are becoming more complicated—many need better trained men. New developments are making new opportunities. Short waves, loud speaker systems, police Radio, auto Radio, aviation Radio, television—Radio's newest uses are covered by my training. Here's a field that's growing. It is where you find growth that you find opportunity.

## HERE'S PROOF

#### Manager, Radio Service Department



"Before taking the N. R. I. Course, I was a 'lunkey' in a furniture store. Now I have a job as manager of the Radio Service Department of one of Mississippi's largest furniture stores. Since starting your Course, I have made over \$3,000."—DAVID J. SHUMAKER, R. 2, Box 105-F, Vicksburg, Miss.

#### Earns Money Quick in Radio

"I joined the N. R. I. and in a few weeks I worked three hours and made clear one five dollar bill. Since that time I have gotten married, have bought my home, a nice place valued at \$3,500 during the so-called depression, and have one of the nicest most pleasant jobs that a man has ever known. And it is all mine, I own it."—E. LAMAR JOHNSTON, 250 Fifth Ave., Rome, Georgia.



#### \$75 IN ONE WEEK



"One week my business netted \$75.00 on repairing alone, and there were sales to be added. I have only you to thank for it. In my estimation, N. R. I. is the best home-study school in the United States."—R. S. LEWIS, Box 514, Pittsfield, Ill.

### Get my FREE LESSON on Radio Servicing Tips

I'll prove that my training is practical, money-making information, that it is easy to understand—that it is just what you need to master Radio. My sample lesson text, "Radio Receiving Troubles—the Cause and Remedy" covers a long list of Radio receiver troubles in A. C., D. C., battery, universal, auto, T. R. F., super-heterodyne, all-wave, and other types of sets. And a cross reference system shows you the probable cause and a quick way to locate and remedy those set troubles. A special section is devoted to receiver check-up, alignment, balancing, neutralizing and tuning. Get this lesson free. No obligation. Just mail coupon.



#### Many Radio Experts Make \$30, \$50, \$75 a Week

Consider these facts—think of the good jobs they stand for. Over 20,000,000 Radio sets in use, over 600 broadcasting stations, over 40 manufacturers of Radio sets, over 2,000 manufacturers of parts, over 100 Police Departments Radio equipped, airplanes and airports Radio equipped. Thousands of ships touching every seaport of the world are Radio equipped. Over 35,000 stores selling sets and parts, over 2,000,000 autos Radio equipped. Loud speaker systems wherever people gather, indoors and outdoors. Commercial Radio stations dotting our coast lines. Radio a big industry—is growing bigger. A few hundred \$30, \$50, \$75 a week jobs have grown to thousands in recent years.

#### Get Ready Now for Jobs Like These

A spare time or full time service shop; installing, maintaining, operating—broadcast, aviation, commercial, ship, television and police stations. A Radio retail or service business of your own. Installing, maintaining, servicing, loud speaker systems. A service or sales job with a store or jobber. I'll train you for good jobs in many branches of Radio.

#### Many Make \$5, \$10, \$15 a Week Extra in Spare Time Almost at Once

Every neighborhood can use a good part time serviceman. The day you enroll I start sending you Extra Money Job Sheets which quickly show you how to do Radio repair jobs common in almost every neighborhood. Get my book—see for yourself that many of my students make \$200 to \$1,000 in their spare time while learning. Stanley Tulk, 1823 Orleans St., Montreal, Canada, writes—"I have been doing so much service work I haven't had time to study. In two months, I made about \$200 in spare time." Lloyd V. Sternberg, 428 Benson Ave., West, Willmar, Minn., tells me—"I earned enough in spare time to pay for my Course. In one month I earned \$125 in spare time." Yes, my training pays!

#### Your Money Back if Not Satisfied

I'll make this agreement with you. If you are not entirely satisfied with my Lesson and Instruction Service when you finish, I'll refund your tuition.

#### Find Out What Radio Offers

Mail the coupon. My book of information on Radio's spare time and full time opportunities is free to ambitious men. Read what Radio offers you. Read about the training I give you. Read letters from graduates—what they are doing and earning. There's no obligation. Mail coupon in an envelope or paste it on a penny post card—NOW.

J. E. SMITH, President, National Radio Institute, Dept. 5NX Washington, D. C.

I have helped hundreds of men make more money



## MAIL THIS NOW!

J. E. SMITH, President National Radio Institute, Department 5NX Washington, D. C.

Dear Mr. Smith: Without obligation, send me the Sample Lesson and your free book about spare time and full time Radio opportunities, and how I can train for them at home in spare time. (Please write plainly.)

NAME.....AGE.....  
 ADDRESS.....  
 CITY.....  
 STATE.....

The Tested Way to BETTER PAY

Please Say That You Saw It in RADIO-CRAFT

# Be Prepared to Meet All Radio Servicing Emergencies WITH GERNSBACK OFFICIAL RADIO SERVICE MANUALS

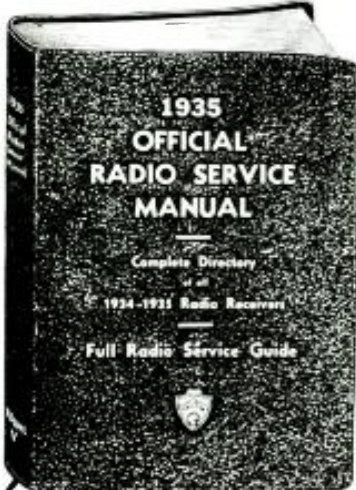

Just as we say—"Be prepared to meet all radio servicing emergencies with the Gernsback Official Radio Service Manuals." You never know when a service job requires that "extra" special attention. It might mean the difference between doing the job or losing it. You're safe if you have on hand the GERNSBACK MANUALS—either for regular service work or for servicing auto-radios. Get your copy today!

No other radio book is comparable to the new 1935 OFFICIAL RADIO SERVICE MANUAL. In contents, in style of printing, in grade of paper, in illustrations, there has never been published such a comprehensive volume.

This Manual contains over a thousand pages—yet it is only 1 1/4 inches thick because it is printed on a special bible stock which is an exceptionally good stock, yet one of the thinnest and most durable papers. This 1935 Manual is the most authentic and elaborate service guide ever used in the radio industry.

## Contents of the 1935 Manual

Over 1,000 pages full of diagrams and essential information of manufactured receivers—only data of real use in servicing is included. This new Manual is really portable since it is extremely thin and light as well. ● Volume V continues where the preceding manual left off. ● Many circuits of old sets are included. ● Service Men know every set has certain weak points which are really the cause of trouble. Wherever the information could be obtained, these weaknesses with their cures are printed right with the circuits. This is an entirely new and valuable addition to the Manual. ● All the latest receivers are included—all-wave sets, short-wave sets, auto-radio sets, midset and cigar-box sets, etc., as well as P.A. Amplifiers and equipment,

and commercial servicing instruments. ● The cumulative index is even more complete than before; including cross-references to sets sold under different names and type numbers. ● Volume V includes resistance data; socket layouts; I.F. data; and voltage data. ● Tube data on latest tubes. ● Free question and answer service—as included in our last three manuals.

**OVER 1000 PAGES**  
**Over 3,000 Illustrations**  
**Size 9" x 12"—only 1 1/4" thick**  
**Flexible, looseleaf leatherette cover**

**SET SERVICING**  
 Service information found in the Manuals covers all types of radio receivers. The material is extremely valuable to Dealers and Service Men. On many diagrams appear voltage readings of tubes, socket connections, transformer data, alignment details, and other service notes.

**PUBLIC ADDRESS**  
 The pages on P.A. installation will be helpful to Service Men and P.A. specialists. Such prominent features as class A and B amplifiers—single and dual channel systems—attenuators, and mixers—superpower stages—preamplifiers and other commercial devices for P.A. work are included.

**ALL WAVE RECEIVERS**  
 Information relative to short-wave receivers have found their way into the Manuals. For these standard manufactured sets, wherever possible, complete aligning details for all wave bands are included in addition to the service material listed for other sets.

**AUTO-RADIO RECEIVERS**  
 All available service information on new auto-radio sets has been included. From this data alone Service Men could derive sufficient knowledge to venture in a specialty field—that of servicing only auto-radios.

**\$7.00**  
 List

### Which of These GERNSBACK RADIO SERVICE MANUALS Do You Need to Complete Your Files?

**1934 Official Radio Service Manual**  
 Over 400 Pages, 9x12 Inches.  
 Over 2,000 Illustrations  
 Flexible, Looseleaf, Leatherette Cover  
 List Price \$3.50

**1933 Official Radio Service Manual**  
 Over 700 Pages, 9x12 Inches.  
 Over 2,000 Illustrations.  
 Flexible, Looseleaf, Leatherette Cover  
 List Price \$5.00

**1932 Official Radio Service Manual**  
 Over 1,000 Pages, 9x12 Inches.  
 Over 2,000 Illustrations  
 Flexible, Looseleaf, Leatherette Cover  
 List Price \$5.00

**1931 Official Radio Service Manual**  
 650 Pages (Including Supplements)  
 9x12 Inches  
 Over 1,500 Illustrations  
 Flexible, Looseleaf, Leatherette Cover  
 List Price \$4.50  
 (Including Supplements)

**1935 Official Auto-Radio Service Manual**  
 (Volume I)  
 Over 200 Pages, 9x12 Inches.  
 Over 500 Illustrations.  
 Flexible, Looseleaf, Leatherette Cover  
 List Price \$2.50

—for the real auto-radio servicing "dope," you can't find a better book!

### The 1935 Official Auto-Radio Service Manual

Every radio man connected in any way with the booming auto-radio business needs a copy of the new OFFICIAL AUTO-RADIO SERVICE MANUAL. It contains only auto-radio service "dope."

#### HERE ARE HIGHLIGHTS OF THE 1935 AUTO-RADIO SERVICE MANUAL

240 pages crowded with diagrams, service material and other essential data required for proper servicing of new auto-radio receivers. Included are diagrams of sets which appeared during 1934, and which were not included in the supplement to the first edition. Complete schematic diagrams, chassis layouts, voltage regulations and servicing instructions are included for practically all sets. "Under side" tube symbols are also included to facilitate the job of servicing the set. Instructions are included with many sets telling how to suppress or remove cases of station interference. This includes the newest "suppression" sets—and what to do when interference is encountered with this type of set. Not only how to make "stopping" repairs are included. The different methods used by set makers and set manufacturers are listed with the inclusion of details and service information. The index contains the listing of sets which were published in the first edition, as well as the sets which appear in the new volume. This information helps the Service Men to locate the circuit and details for any receiver that has been made. The book is bound in a handy, flexible leatherette cover. To be sure the pages are sturdy, to withstand constant use, the book is printed on a special "bible" stock. This is a very durable, but thin paper. The book printed on this paper is so easily rolled to fit into your pocket or slipped in the service kit.



**240 Pages**  
 Over 500 Illustrations  
 Size 9 x 12"  
 Flexible, Looseleaf Leatherette Cover

**\$2.50**  
 LIST

### MAIL COUPON TODAY FOR ANY MANUAL!

GERNSBACK PUBLICATIONS, Inc. RC-1235  
 99 Hudson Street, New York, N. Y.

Enclosed you will find my remittance of \$ ..... for which please send me promptly, POSTPAID, the OFFICIAL RADIO SERVICE MANUAL indicated.

- |  |  |
|--|--|
| <input type="checkbox"/> 1935 Edition @ \$7.00                         | <input type="checkbox"/> 1935 Edition @ \$2.50 |
| <input type="checkbox"/> 1934 Edition @ \$3.50                         | <input type="checkbox"/> 1933 Edition @ \$2.50 |
| <input type="checkbox"/> 1933 Edition @ \$5.00                         | <input type="checkbox"/> 1932 Edition @ \$5.00 |
| <input type="checkbox"/> 1931 Edition @ \$4.50 (Including Supplements) |  |

Name .....

Address .....

City ..... State .....

(Send remittance by check, money order, or registered letter if it contains cash, currency or un-used U. S. Postage Stamps.)

**GERNSBACK PUBLICATIONS, Inc.**  
 99 Hudson Street New York, N. Y.

**OVERSEAS READERS!**  
 These books can be obtained from the following houses:

**GREAT BRITAIN**  
 Gorrings's, 9a, Green Street, Leicester Square, London, England

**FRANCE**  
 Editions Radio, 42 Rue Jacob, Paris

**AUSTRALIA**  
 McGill's 183-195, 218 Elizabeth St., Melbourne, C. J.

Please Say That You Saw It in RADIO-CRAFT





# RADIO EXPERIMENTING

An Editorial by HUGO GERNSBACK

**E**VER since the days when radio was called wireless, experimentation has been a vastly important element in the development of radio as a whole, whether the experimenter pursued the art only as a hobby or whether he did so with a view to commercializing his experiments later on. The fact remains that radio experimentation in its various forms still is one of the really great hobbies—not only in the United States, but the world over.

I have often remarked that the best available figures show there are no less than 100,000 radio experimenters constantly engaged in this pursuit in the United States alone. This figure is based on consumer purchases of books, magazines, and radio apparatus. When it is realized that there are several radio mail order houses in this country which issue catalogs to the tune of 300,000 copies, several times a year, and that there are numerous other concerns which issue similar catalogs in editions of 50,000 to 75,000 copies, also several times a year, the figure of 100,000 experimenters does not seem excessive.

Also remember that radio has many ramifications today and that when we mention a "radio experimenter," we do not necessarily refer to the man who just builds and tinkers with radio sets. While this pastime also falls under the classification of radio experimenting, it is only a fraction of the experimentation done in this country today. "Radio" (and most applications that include the vacuum tube) is divided into a large number of classifications, in each of which continuous experimentation is going on.

Of course, *radio set building*, whether it is for broadcast purposes, for short waves, or for ultra-short waves, is an unending pursuit. This condition has been enhanced since the advent of the new metal tubes, which have stimulated set building of all types to a tremendous degree; so much so, that supply houses feel themselves hard pressed to supply the demand for such tubes.

Then, we have the *vacuum tube amplifier* with its thousands of uses, and here alone is a big field for the experimenter. This field today is continuously expanding. Experimenters are always building special amplifiers for special purposes, sometimes just as a hobby and sometimes for profit.

*Radio recording*, still considered in its infancy, is another branch of radio that has many adherents. There are actually thousands who record the feature programs which are broadcast daily. Additional thousands have recently sprung up who, for verification purposes, record short-wave broadcasts from distant lands and carefully preserve such records.

*Electronics* is yet another, especially interesting field for the experimenter, these days, simply because so much can be done in it. By means of photoelectric tubes any number of experiments can be made, many of which are not only startling but are often instructive, and it may be said that the surface, as yet, has not been scratched when it comes to experimentation in this particular branch of radio. Equipment is being turned out at lower prices than ever before, and no well-equipped radio laboratory can be imagined these days, without its quota of "PE." (photoelectric) cells.

Then, of course, we have the great host (close to 50,000) of *radio amateurs*, most of whom are experimenters—one

way or another. At the present time, a large percentage of radio amateurs pursue their experiments by supplementing their code equipment with "phone." In addition to this, the radio amateurs are now turning in increasing numbers to the 5-meter band and even to higher frequencies. Every amateur worth his salt has, or is trying to build a 5-meter transceiver, by which two-way communication can be held, sometimes over great distances. In addition to this, amateurs are doing a tremendous amount of experimentation and research work with the so-called ultra-short or, (as it is sometimes called) "decimeter" waves. This, also, is practically a virgin field for the experimenter; and one which is coming more and more into use every day.

The serious experimenter also devotes a good deal of time these days in *radio telemechanics*, that branch of radio whereby mechanical objects can be controlled at a distance. Of late, many experimenters, among whom are a good many Service Men, have built radio "robots" which are able to move their arms and legs and do a variety of other surprising tricks—all through radio means. These robots are always a matter of tremendous curiosity to the public and wherever one of them is demonstrated it is found necessary to call the police reserves in order to clear the streets, particularly where it is exhibited at the entrance to a store!

While *television* at the present time does not have much to offer to the experimenter, nevertheless there are always a goodly number of television experimenters who are experimenting with new equipment and new instrumentalities, which bring us closer to the solution of the problem. As soon as television images are broadcast, the television experimenters of the country will begin to multiply, and thousands of television experimenters will spring up overnight to try pet circuits and equipment.

Even the *Service Man*, believe it or not, is an ardent experimenter. He, perhaps more than others, from the letters which continually reach us, seems, at the present time to be in the vanguard of experimenters. As the Service Man usually has a good foundation in radio, he dabbles in many different branches of the art. Thus, for instance, he is never satisfied with the testing equipment which he owns, but is forever designing or inventing new test equipment for a particular service.

In the field of *radio therapeutics*, where short waves are used to cure diseases, there is a great deal of experimental work going on. Usually we find a group of experimenters allied, such as a physician in conjunction with a radio technician, in order to find ways and means to lighten the sufferings of humanity. Such an alliance is important because most medical men know little of radio and radio men know little of medicine. Jointly, a good deal of progress can be made by such experimenters and much good work is being done.

Then, of course, we have the tremendously alluring *radio treasure-finding* branch. This, at the present time, seems to be one of the most interesting fields if the number of letters reaching us is an index. Literally hundreds of new types of equipment are being worked out by experimenters, not only in attempts to locate buried treasure but for many, more practical purposes, such as locating pipes, electric conduits, etc. This particular branch of radio promises rich rewards to experimenters during the next few years.



# IN REVIEW

Radio is now such a vast and diversified art it becomes necessary to make a general survey of important monthly developments. RADIO-CRAFT analyzes these developments and presents a review of those items which interest all.

## NEWSPAPER—RADIO FIGHT CONTINUES

**T**HE controversy which started some months ago, between the newspaper interests and those radio stations which broadcast news reports reached a climax, last month, with some new accusations by the Bureau of Advertising of the American Newspaper Publishers' Association.

It was pointed out that the "mortality" among broadcast advertisers with relation to the renewal of radio advertising contracts is unusually high. The highlight of ANPA's survey follows:

"Of the 635 advertisers who bought time on the air for some period between 1929 and 1933, inclusive, 448—or 70.6 per cent—had dropped radio in 1934."

In answer to the above charges, CBS claims that 80 per cent of its present clientele is on a renewal basis; NBC is said to be about the same, if not higher!

And to top off the inconsistencies of the ANPA claims, the Scripps-Howard newspaper alliance filed application for broadcast facilities in Cincinnati, Columbus and Toledo, preparatory to seeking broadcast affiliations in the 24 cities in which it publishes papers!

## PRESIDENT TALKS OVER LIGHT BEAM!

**T**HE "talking light beam" which G. E. has been playing with for the past few months stepped out of the class of laboratory novelties into the legitimate field of communications, last month, when President Roosevelt talked from the top of Whiteface Mountain to the Lake Placid airport (N.Y.), a distance of 6 or 7 miles!

In this method of communication, a powerful searchlight is modulated by the voice frequencies. (See *Radio-Craft*, Sept., 1934)

The talking light beam which was used by President Roosevelt, on the top of Whiteface Mountain.



## N.Y. NOISE CRUSADE CONSIDERS RADIO

**I**N SETTING up a definite schedule for abating the noise which is annoying the honorable Mayor of New York City, technicians have labored hard.

Among the many sources of "noise," radio was not omitted and it is interesting to note that in the report of the committee, last month, it was mentioned that radio sets which "can be heard by neighbors are not now permitted under police regulations between 11 o'clock at night and 7 a.m." (Hear the headphone brigade cheer!)

It was stated that the charivari of apartment house sets was "the most cruel and unusual of city noises."

## ARMY "WILD ON RADIO"

**A**T THE end of the field manoeuvres of the U.S. Army in upper New York State, last month, General Fox Conner, commander of the First Corps, made some caustic comments.

In part, the General stated—  
"Personally, I think we've gone perfectly wild on the subject of radio. We're spending an awful lot of money on radio, I think it should be cut out and spent on laboratory work for developing telephony and other forms of communication."

Citing the "jamming" of allied radio signals by the Germans during the war and its vulnerability today to interference, General Conner insisted that "we've got to have the telephone; we've got to have the telephone service; we've got to spend our money on that and we're not doing it."

Our own humble opinion regarding the General's comments is that he does not realize that there are such things as ultra-high frequencies—and that radio has advanced since the World War!

This tank was directed by radio in the recent manoeuvres—note the aerial.



Jean Darlington with her radio set by which her daddy (upper left) calls her from play.

## ENGINEER CALLS DAUGHTER FROM PLAY BY RADIO

**O**NE of those odd uses for radio communication which are forever cropping up came to light last month in the form of a radio device for calling a small girl from play in a neighboring playground, devised by her engineer father.

Like Mary with her lamb, no matter where little Jean Darlington wanders, the radio is sure to go. She trails it behind her in a small cart. When daddy Darlington desires to call her from play, he puts through a call with his amateur transmitter. The receiver is permanently tuned to his station and is in constant operation. Being an obedient little girl, she returns home.

## HARLEM RADIO SETS GO DEAD—BAFFLING EXPERTS

**A** DRAMATIC little playlet was enacted one day last month, in the Harlem section of "Bagdad on the Hudson."

Act one: a domestic scene in any one of a number of apartments—the dramatic emphasis is on the home and fire-side angle with family group clustered about the radio, listening to a favorite program.

Suddenly the radio stops and there is a frantic turning of the dial, followed by a hurried call to the local Service Man—who is obviously baffled by the silence of the set!

Act two: Harlem court, next morning  
(Continued on page 356)



A picture of Lee DeForest taken in 1907.



Hiram Percy Maxim



Philo T. Farnsworth



McMurdo Silver with an early all-wave receiver.



M. B. Sleeper working in his lab. in 1925.

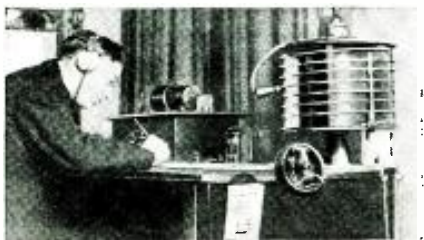

Amateur Arthur H. Lynch and station AL, in 1912.

John V. L. Hogan, experimenting, in 1920.



# WHAT PROMINENT RADIO MEN SAY ABOUT THE HOME LABORATORY

There is, perhaps no better way to determine the value of home labs. than from well-known men who used them.

**T**HE FOLLOWING interesting views on the importance of the home laboratory are presented by radio men who have distinguished themselves by achievements that constitute the very foundation of radio in all its phases.

## LEE DE FOREST\*

The history of invention is replete with instances where the germ of an important idea or discovery originated in the home laboratory. I dare say that most of the world's greatest industrial developments primarily originated there rather than in the shop, the school, or the professional laboratory.

The steaming tea-kettle on the hearth of Watts, the kitchen stove of  
(Continued on page 358)

## HIRAM PERCY MAXIM\*

A home experimental laboratory, and its consistent use, is an insurance policy that almost guarantees a good job in later business life. I say this after 22 years' experience as President of The American Radio Relay League, during which time I have seen thousands of young men secure good positions because of the experience gained in their home experimental laboratories.

\*(Pres., The American Radio Relay League)

## PHILO T. FARNSWORTH\*

It has always seemed rather a pity to me that the amateur experimenter is always forced to new frontiers once the field he has been exploring becomes useful commercially. Since it appears likely that the same thing will happen in the amateur 5-meter band, it would only seem fair that the "hams" be given an opportunity to help pioneer television.

It is my belief that it is technically feasible for radio experimenters to

build their own television receivers, and to this end I intend to publish sufficient technical information to permit at least the best qualified radio amateurs to construct their own television receivers. This information will be released as soon as a few television broadcasting stations are operating on consistent experimental schedules.

The cost of parts for such television receivers will be somewhere in the range of from \$50 to \$100. We expect that by opening the television art to the amateur experimenter, television will progress much more rapidly towards a commercial service.

\*(Vice-Pres., in Charge Research, Farnsworth Television, Inc.)

## McMURDO SILVER\*

The best evidence of the importance of radio and electrical experimentation at home is the large number of important developments and inventions which have come from such laboratories—developments which even in as complicated and precise an art as radio are still substantially as frequent as the developments that come from the larger and completely equipped research laboratories.

As a source of training, as well as of potential invention the importance of home experiment cannot be too greatly emphasized.

\*(McMurdo Silver Corp.)

## MILTON B. SLEEPER\*

One of the most valuable things about the home workshop for any young man is that it gives him an opportunity to find out in his spare time if he is really interested in making a life work of experimental engineering or research work. In this way he can determine if his interest is just as a hobby or if it is as a vocation to which he will want to devote his life's work.  
(Continued on page 360)

\*(19104 Radio Corp.)

R. H. Ranger testing an electric chime, in 1934.



Wm. Dubilier with an early tube transmitter.

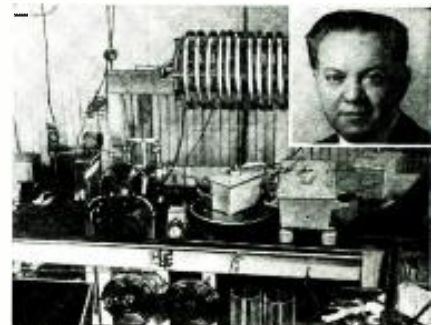

# RADIO PICTORIAL

Read about "reincarnated voices"; and Berlin's method of eliminating "ech<sup>o</sup>" in P.A.

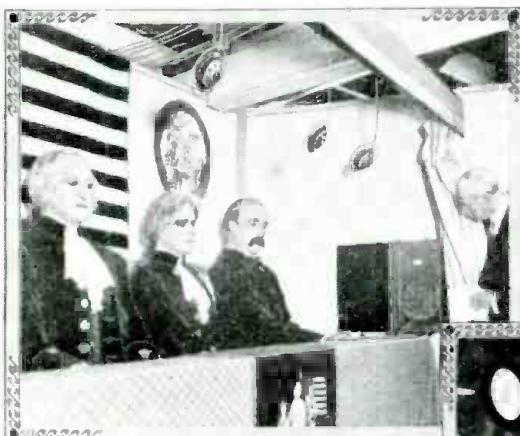

**THE PRESIDENTS "TALK!"**  
A historical sketch and educational exhibit has been recently set up, which is historically correct in every detail, even to the speakers' voices. At left, Charles W. Clark shows the concealed reproducer which gives the life-like figures their "voice." The overhead microphones are dummies. Right, "Lincoln" has arisen to give a part of one of his famous addresses.



Center, Mr. Clark at the levers which control the movements of the figures. The action is observed through the slits in the wall. The reproducing machine, developed by Arthur C. Ansley, is in the foreground. Below, we see a close-up of this unit, showing the amplifier chassis. A new circuit has been utilized to enable the use of type 48 tubes in an A.C.-D.C. circuit. This is claimed to be one of the finest universal-current amplifiers yet brought out. Screwdriver adjustment of the hum-balancing circuit is being made in this view of the "dynaphone."

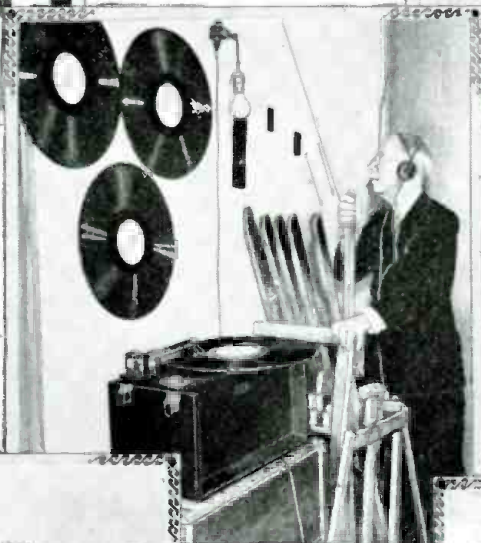

Below, the loudspeaker of the historical talking sketch. The equipment necessarily had to be made portable since the exhibit is moved from city to city for display. Therefore, this speaker unit and the amplifying unit pictured opposite are made to fit together compactly into one convenient "package." Since the cabinet had to be made as compact as possible, more baffle area was needed for the speaker. This was provided for by making the sides of the speaker cabinet large enough so that they may be used for additional baffle area; they can be swung around to change the response as desired. A tone control is available on this system, as well as a jack for the use of a microphone.

(Halbran Photos)



The auxiliary microphone shown directly below, in its own pit, is connected to a small amplifier and its own individual speaker. The airline distance from the main speaker to the auxiliary ones is carefully checked and the pipeline made the same length. The listeners at a distance from the speaker hear the voice arrive with the same time delay as they would if no P.A. equipment were used.



**IMPROVED PUBLIC ADDRESS SYSTEM FOR LARGE ASSEMBLIES.** Large audiences covered by public address and reinforcement systems are often disturbed by the echo effects, caused by the difference in velocity between sound in air and electrical impulses in conductors. This problem has been solved at the great Post stadium in Berlin, Germany, by the use of a system of pipelines for the transmission of the sound impulses, in place of the more rapid electrical transmission method. Below, we see the "master speaker," installed in the center of the stadium. The sound impulses are sent from here over pipes to microphones on the outskirts of the stadium. There they are amplified by small, individual amplifiers. One of these secondary microphones in its pit is shown at the right. Special means have to be taken to insure natural tone, and to this end tuned resonators are used in the pipelines which boost the desired frequencies. The sound velocity in the pipeline and in the air is made equal by special design of the lines. This is an important development in sound reinforcement.

Below at right, is one of the auxiliary speakers mounted in front of the tribune. Each of these units has its own small power amplifier located near it.

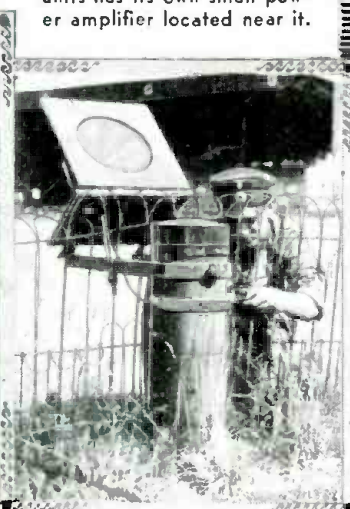

# INTERNATIONAL RADIO REVIEW

RADIO-CRAFT receives hundreds of magazines from all parts of the world. Since the cost of subscribing to each of these would be prohibitive for most radio men, we have arranged with technical translators to prepare reviews for our readers.

## A CALIBRATED A.F. GENERATOR

WHILE the radio experimenter has no difficulty in making an audio oscillator from any of the numerous descriptions which have been presented in magazines, there are cases where calibration of the oscillator is essential for certain experiments. For example, if the frequency response of an A.F. amplifier is to be checked, a calibrated signal generator must be used.

A recent issue of *Wireless World* contained a description of a generator which should be of interest to the radio man who has need for such a unit.

As shown in the photo, Fig. A and circuit Fig. 1, the generator consists of a motor equipped with two soft-iron discs. One disc contains 40 holes drilled equi-distant around the edge. This is mounted between the poles of a U-shaped magnet on which is a coil of fine wire.

The second disc is pentagon-shaped, also made of soft iron and mounted between the pole pieces of an ordinary phone unit, so that the points of the pentagon come between the poles, but the flat edges are above the level of the phone unit. On the outer face of this disc is a white radius line, the rest of the disc being painted black. A neon tube is mounted adjacent to the disc and is connected to a 50-cycle supply line (in the U.S. it would be connected to the 60-cycle line and a hexagonal disc would be used in place of the pentagon). The purpose of this white line and neon tube is to form a stroboscope for controlling the speed of the motor. A rheostat is provided for this control.

If the motor is revolving at 100 revolutions a second, the 40-hole disc is cutting the field of the magnet 4,000 times and the coil will have a 4,000-cycle note (current) induced in it. At the same time, the pentagonal disc will generate a 500-cycle tone. The frequencies generated are given by the simple formula,  $n \times 100/1$ , where  $n$  = number of holes or points on the disc,

Fig. C. A phono. attachment for table sets.

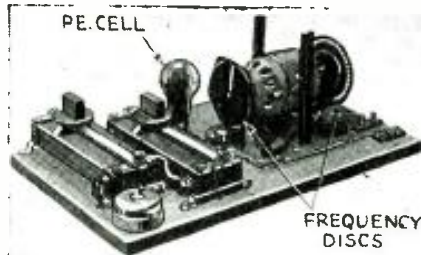

Fig. A. The experimenter's A.F. generator.

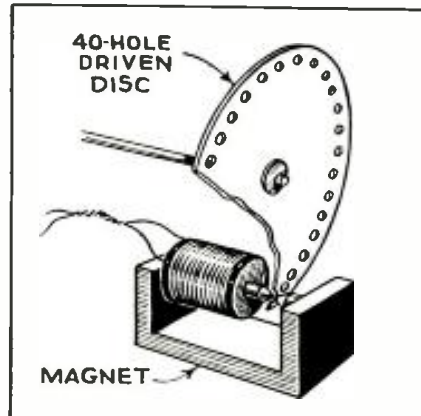

Fig. 1. The circuit of the high-frequency wheel.

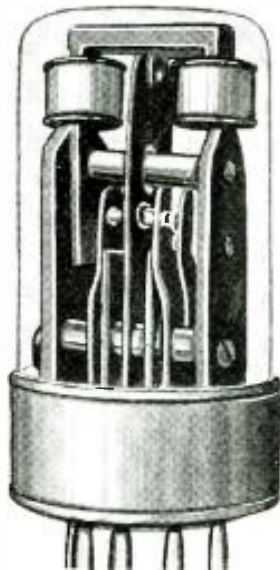

Fig. B, above. A rectifier for auto sets.

Fig. D, below. A novel service oscillator.



and 1—the stationary lines seen on the stroboscope.

## AN ITALIAN REPLACEMENT VIBRATOR-"B"

AUTO RADIO has now developed in Europe to a point where vibrator-type inverters are in demand for replacement purposes! As we pointed out some months ago on this page, auto-radio sets in Europe were far behind the state of development in the U.S.

However, their battery sets have now been replaced with power-operated models, using the same type of vibrator-inverter employed so extensively, here.

The particular vibrator shown, although it appeared in *Radio Industria*, a magazine published in Milan, Italy, is of German origin.

## A HANDY PHONO. ATTACHMENT

THE MAGAZINE *Radio Revista*, a Buenos Aires radio publication, recently ran the illustration shown in Fig. C.

This is a phonograph attachment to be added to existing sets of the table type. The unit forms a base for the set, improving its appearance and facilitating tuning by providing a rest for the hand.

The experimenter who wishes to try his hand at duplicating this handy attachment will have no difficulty, if the shape of the phono. cabinet shown, is followed.

## AN AUSTRALIAN SIGNAL GENERATOR

AN AUSTRALIAN idea of how a service oscillator should be made is shown in Fig. D. The unit is completely portable and is housed in a neat case provided with a carrying handle.

The oscillator is modulated by a vacuum-tube modu- (Continued on page 357)

Fig. E. A new and unusual I.F. transformer.

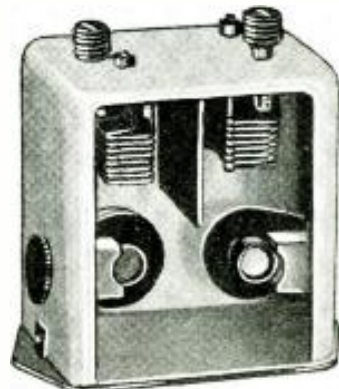

AWARDS IN THE CONTEST	
FIRST PRIZE.....	\$10.00
SECOND PRIZE.....	5.00
THIRD PRIZE.....	5.00
Honorable Mention	

# USEFUL CIRCUIT IDEAS

Experimenters: Here is your Opportunity to win a prize for your pet circuit idea, if it is new, novel and useful.

## FIRST PRIZE—\$10.00

**REGENERATION CONTROL.** A screen-grid or pentode detector must have the proper voltage on the screen, in order to maintain high sensitivity. With some regeneration schemes, the screen-grid voltage is varied, with the result that the screen-grid is run 'way below the proper point, even though regeneration is secured. The circuit shown in Fig. 1 enables proper voltage to be used in the electron-coupled circuit, yet smooth, perfect regeneration is possible. The screen-grid can be set at the optimum value, and perfect set operation is secured.

WM. WALLACE,  
Mimico, Ont., Can.

## SECOND PRIZE—\$5.00

**TUBE TESTER.** This tester is designed particularly for the rural Service Man, or anyone who must test tubes without the use of power from the light lines. It will test the most widely-used battery tubes. The equipment may be assembled in a small box, and small-size batteries may be included, if desired, to make the unit entirely self-contained. Socket No. 1 is for 01A, 01AA, 71A, 30, and 31 tubes. Socket No. 2 takes the 32 and 34s, while Socket No. 3 is used for 33s. The tester should be calibrated with new, good tubes. All tubes are tested first with switch Sw. 1 closed and Sw. 2 open. A good tube will show a fluctuation upon opening and closing Sw. 1. The screen-grids are tested the same way—but by opening and closing Sw. 2.

FLOYD M. GLASS

## THIRD PRIZE—\$5.00

**CONDENSER TESTER.** This novel circuit will test condensers as low as 50 mmf. Enough plate voltage is used on V2 to cause the meter to swing to maximum with no voltage applied to V1. The latter tube acts as a rectifier, and when A.C. is applied to it, a varying voltage will be applied in turn to the grid of V2. This voltage will vary in accordance with the size of the condenser being tested. By closing the switch, resistance or

A.C. volts may be read at the proper binding posts. Inductance can also be measured. Calibration is made by comparison with known values.

ARTHUR ZAGON

## HONORABLE MENTION

**AUTOMATIC LIGHTNING PROTECTOR.** A set is often damaged by a heavy charge picked up in a long antenna, even though the lightning strikes a good distance away. The relay shown in Fig. 5 automatically disconnects the aerial and ground from the set, when it is not in use, and grounds the antenna directly. It may be operated from any circuit in the set where the power for the relay can be obtained.

NELSON STOVER

## HONORABLE MENTION

**POWER DETECTOR.** This system is very valuable where higher fidelity is wanted, with comparatively low audio power output. The parts should be of the highest quality possible. With 250 V. for the plate supply, the audio output is around 1 W. The grid leak may need a little experimenting with, and as a rule the lower in value it is, the better the high-note response will be. See Fig. 6.

ROBERT C. POTTER

## HONORABLE MENTION

**TUBE PROTECTION.** A scheme to protect tube filaments from accidental overload of any kind is shown in Fig. 7. The S.P.D.T. switch should be mounted on the bench so that any set connected to the "A"-battery lines will be protected. The switch simultaneously opens the battery circuit, and shorts the "A" leads from the tubes, so that even if the "B"-battery leads accidentally get across the filament circuit, no harm can be done to the tubes.

DONALD J. RITCHIE  
Lismore, N.S.W.

The following novel circuits, while not contributed, are printed because they are of interest to the experimenter.

**ELECTRICAL MICROMETER.** Many requests have been received for a circuit of an "electrical micrometer." Figure 9 shows such a circuit, while Fig. 8 gives a detail of the micrometer "head." The arrangement consists of 2 oscillators, one of which is fixed. The variable oscillator is connected to, and tuned by, the plates of the micrometer. Moving the top plate and thus changing the capacity, changes the frequency of oscillator V1, this change causing galvanometer G to move. This particular equipment works on 2,000 kc. No constants are given since the technician will doubtless have his own ideas about them.

The principle is that which is common to all ultra-micrometers—the various types differing only in their method of measuring the change of frequency produced by the displacement.

By making the spacing between the plates very small the frequency change will be relatively large for small plate displacement. By substituting this frequency change for a displacement change, the instrument gains greatly in sensitivity.

The potentiometer F must be set so that the galvanometer reads on-scale, and for large displacements the potentiometer must be constantly adjusted, while for very small displacements, the change can be watched on the meter.

It must be emphasized that the apparatus here is of the highest precision type, but the principle is very interesting, and might be put to use by the home mechanic.

(Bell Labs. Record)

**SECRET TELEGRAPH.** A circuit for receiving telegraph "clicks" without a sounder is shown in Fig. 4; C and R are adjusted until the correct sound is obtained in the headphone. This arrangement may be used where secrecy is desired.

The use of this circuit provides a distinctly different tone between the make and break, so that the effect is very similar to that obtained with the conventional telegraph sounder.

(U. S. Patent Office)

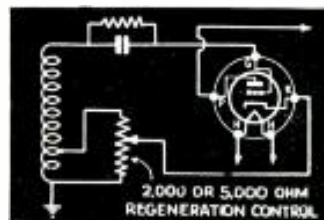

Fig. 1, above. Regeneration control.

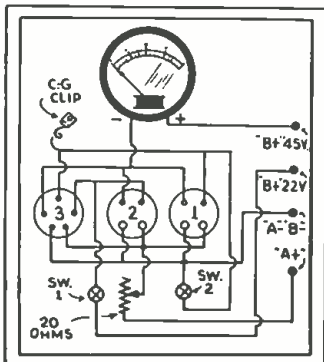

Fig. 2. Self-contained tube tester.

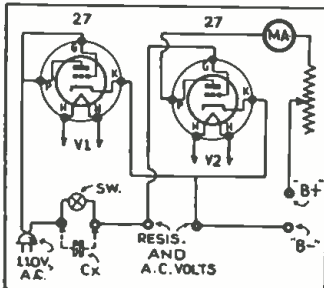

Fig. 3. Novel condenser tester.

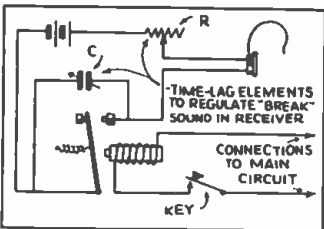

Fig. 4. Secret telegraph.

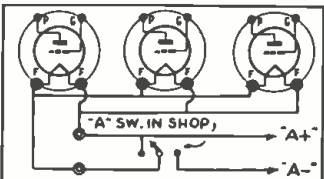

Fig. 7, above. Filament protection.

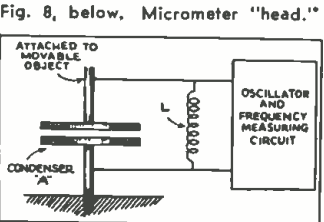

Fig. 8, below. Micrometer "head."

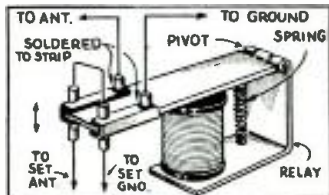

Fig. 5, above. Automatic protector.

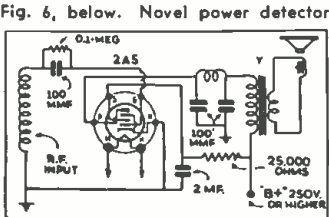
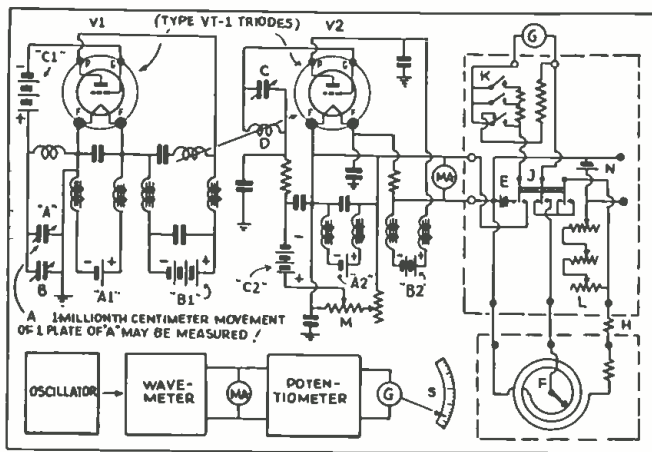

Fig. 6, below. Novel power detector.

Fig. 9. Circuit of the Ultra-Micrometer, which is extremely sensitive.



# THE LISTENING POST FOR ALL-WAVE DX-ERS

C. A. MORRISON

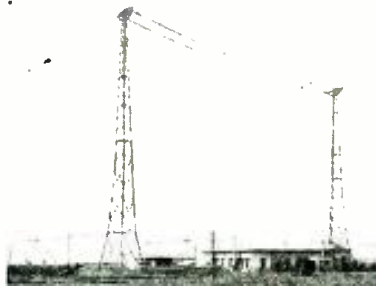

The Shimizu transmitting station of JOGK, Kumamoto, Japan—showing the antenna system.

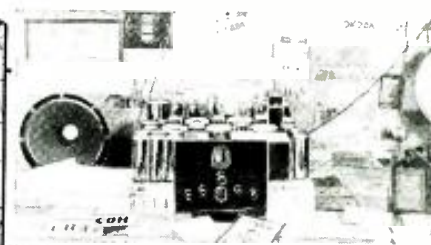
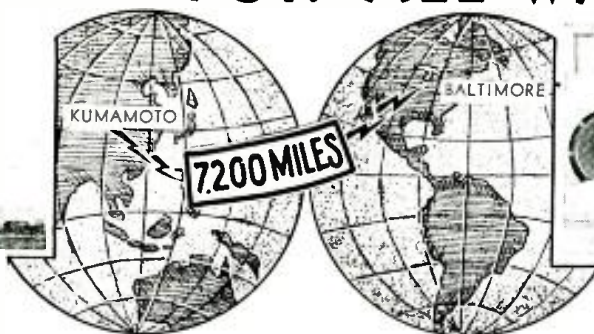

The listening post and unusual collection of verifications of Robert Base, Baltimore, Md.

## "AMA-TOURING"

**A**N EXCITING new DX game has been evolved, which can be played by any listener having an all-wave receiver. Derived from the words "Amateur," and "Touring," it is called "Ama-Touring," as it deals with arm-chair excursions into the thrill bands of foreign amateur reception!

The idea is to classify various foreign countries from which amateurs are regularly received on a "point" basis, and then see how many points can be run up in a given length of time.

In different sections of the country, different handicaps would have to be worked out, but here is a sample scale that was used in the central United States: Mexican, Cuban, or Canadian hams (amateurs), 2 points (each). Bermuda, Newfoundland, or West Indies (except Cuba), 3 points (each). Hawaii, or Central America 4 points (each). South America, or Europe, 6 points (each). Australia, or New Zealand 10 points (each). Africa, or Asia, 30 points (each). (Some may wish to add the most distant U.S. amateur district, for 1 point each. We used W6s for 1 point each to add to the excitement.—*Editor*)

Ama-Touring is generally restricted to the phone stations in the middle of the "20-meter" amateur channel, which takes in roughly from 14 to 14.4 megacycles. During the winter season the 3.9 to 4 megacycle phone stations in the "75-meter" channel may be used during the long nights with excellent results. For a contest which might cover several hours, or even days, you might use a combination of phone stations in the 20-meter, and 75-meter bands for day, and night DX-ing, respectively.

Ama-Touring may be played by one, two or a dozen DX-ers in the same general locality. In the case of one person, the idea would be (a) to beat your own record, (b) some one else's previously established or, (c) set up a record of your own for others to shoot at. I think the most fun may be derived from two or more DX-ers in the same locality competing during the same time period, and with a pre-established set of points. In this game

honesty is essential, and a listener must never log a station unless the call is clearly heard beyond the shadow of a doubt. The final results will depend upon many factors, including patience, skill, location, receiver, antenna, and general knowledge of short-wave DX-ing. For instance, two DX-ers using different receivers in the same house, during the same one-hour period, *logged an almost entirely different set of hams!* Your log should include the call, location, dial setting, number of points, and time heard for each station.

Periods of from one hour to several days, may be used at the discretion of the competitors, but the greatest thrill is the 24-hour week-end marathon. Brew yourself a pot of black coffee, prepare a large plate of sandwiches, lock the door to your DX den, and you are ready for a 24-hour vigil. If you prefer, another DX-er may sit-in with you as an assistant, and you can work in shifts.

Just to show how this can be worked out, here is a sample log based on the previously mentioned point scale, which was run-up in an average half-hour's dial twirling by your Editor,

Antenna towers and transmitter building of station XGOA—the 75 kw. transmitter at Nanking, China—A fine DX catch.

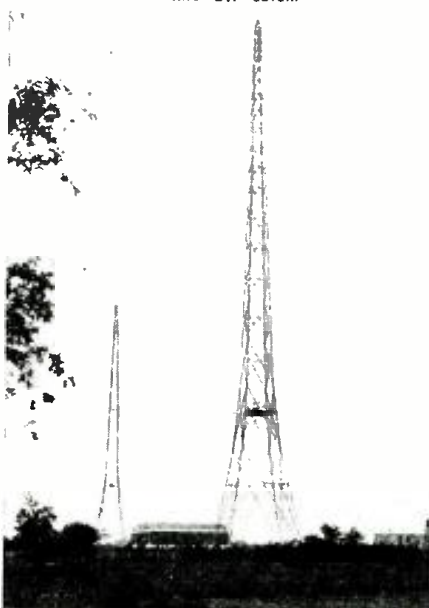

Location and Call Points	Dial	Time
F8DR, Paris, France.....6	96	4:03pm
VE4HB, Ghost Pine Creek, Alta. Can...2	110	4:08
HH5PA, Port-au-Prince, Haiti.....3	6	4:09
H17G, Santo Domingo, Dom. Rep....3	9	4:10
T12RC, San Jose, Costa Rica.....4	12	4:11
G5ML, Kenilworth, England.....6	13 1/2	4:12
VP6YB, Barbados Islands.....3	106 1/2	4:18
VP9R, Devonshire, Bermuda.....3	109 1/2	4:25
VP5AB, Kingston, Jamaica.....3	106	4:28
W6JYH, Los Angeles, Calif.....1	111	4:32

TOTAL POINTS...34

## RADIO-CRAFT'S FOREIGN DX BROADCAST SCHEDULE NOV.-DEC.

Sun., Nov. 4, Radio Normandie, Fecamp, France, 1.113 kc., 3:00-3:30 a.m. E.S.T. Address: IBC Program Dept., 11 Hallam St., London, England.
Tues., Nov. 19, Radio Marseille, Marseille, France, 749 kc., 1:30-2:30 a.m. E.S.T. Address: Minister des P.T.T., Radio Marseille, Marseille, France.
Tues., Nov. 19, CPX, La Paz, Bolivia, 1,230 kc., 10 kw., 3:00-4:00 a.m. E.S.T. Address: Radio Nacional de Bolivia, Casilla Correo No. 596, La Paz, Bolivia.
Tues., Nov. 26, OKI, Brno, Czechoslovakia, 922 kc., 32 kw., 1:00-3:00 a.m. E.S.T. Address: Radio Journal, Odbojka Brno OKI, Kounilova No. 41, Brno, Czechoslovakia.
Fri., Nov. 29, IGP, Genoa, Italy, 986 kc., 10 kw., 1:15-1:45 a.m. E.S.T. Address: E.I.A.R., Via Arsenale 21, Torino, Italy.
Sun., Dec. 1, CP4, La Paz, Bolivia, 1,040 kc., 2:00-3:00 a.m. E.S.T. Address: Compania Radio Boliviana, Casilla 637, La Paz, Bolivia.
Mon., Dec. 2, HV39, Moscow, U.S.S.R., 832 kc., 100 kw., 1:30-2:30 a.m. E.S.T. Address: B. Siglin, Comite de Radiodifusion, Petrovka No. 12, Moscow, U.S.S.R.
Sun., Dec. 22, Radio Strasbourg, Strasbourg, France, 859 kc., 40 kw., 1:30-2:30 a.m. E.S.T. Address: Radiodifusion National, Association Radio Strasbourg P.T.T., Strasbourg No. 63, Strasbourg, France.
Tues., Dec. 24, ITO, Turin, Italy, 1,140 kc., 7 kw., 1:15-1:45 a.m. E.S.T. Address: E.I.A.R., Via Arsenale 21, Torino, Italy.

## BROADCAST BAND, NOV.-DEC.

Australian and New Zealand signals generally reach peak-signal strength during October and early November, but this year we have reason to believe that signals from "down and under" will be heard throughout the winter with fair volume, because of the general increase in signal strength (of the stations), and the several powerful new stations going on the air. Reception of Australian and New Zealand stations falls off slightly during mid-winter here because at this time it is mid-summer in the southern hemisphere. The best hour to listen for trans-Pacifcs from this region is about an hour before sunrise in the East, on those channels that are not being

(Continued on page 358)



# NEW METAL CORES FOR R.F. COILS

The experimenter will welcome these new high-permeability cores for R.F. and I.F. coils which permit higher "Q" factors.

HENRY L. CROWLEY\*

**T**HE GROWING acceptance of a radically new metallic core material in place of usual air core in R.F. and I.F. coil designs promises entirely new standards of performance for these circuits in the modern radio receiver. For, generally speaking, these new alloy cores double the selectivity and gain over corresponding air-core coils, and cut the power factor in half (which means doubling the "Q" factor).

The need for a truly practical high-frequency core material combining extremely high permeability with minimum hysteresis at radio and intermediate frequencies, and providing positive uniformity from piece to piece throughout a long life, has long been recognized.

By a long process of testing and eliminating many new materials, combinations and methods, our choice in the search finally narrowed down to a *magnesium ferrous alloy* as the ideal material. And in addition to these finely-divided metallic particles, an extensive experience in the radio ceramics field was drawn upon for a suitable insulator and binder, ultimately settling on one of the crolite ceramic formulas. The choice of a ceramic insulator is essential for a satisfactory high-frequency metallic core. It is well known that all insulators decrease in insulation value as frequency

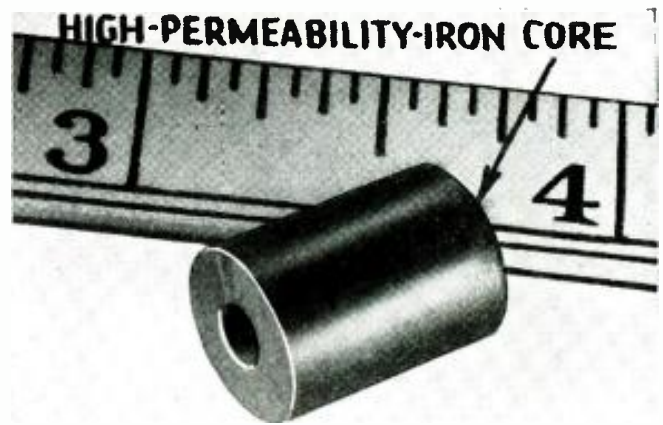

increases. This is especially so with the so-called organic type or resinous insulators. But since the critical frequencies are well within the insulation range of crolite, the drop in resistance value is negligible. Consequently, we have a suitable finely-divided metallic structure adequately insulated and imbedded in a ceramic body.

### How "Magicores" Are Made

To produce a usable core we have followed the familiar extrusion process whereby the material is forced through a die in continuous lengths for any given cross-section, instead of being molded or pressed. The continuous lengths are cut into small pieces and fired at high temperatures in accordance with ceramic practice. The resulting finished cores, called "magicores" (see illustration), are of smooth, hard, clean-cut, silvery metallic appearance, and quite uniform in mechanical and electrical (Continued on page 357)

\*Advertiser's name on request.

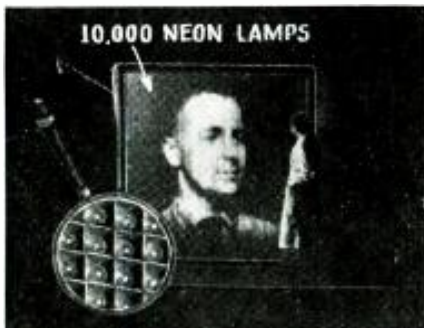

In the photo above and to the right are shown two views of a new German television set-up for theatre use. A 1,000 W. lamp illuminates the subject, while a rotating mirror-drum "scans" him. At the receiving end, a honeycomb of 10,000 neon lamps produces the large image.

**T**HE COMPARISON of theatre pictures with television pictures is continued here, where we so inadvertently left off, last month, due to lack of space. It is hoped that the reader will forgive us for cutting this interesting tabular comparison which Dr. Goldsmith has made, and will not mind referring to the preceding Part I for the first five items.—*Editor*

(6) **Size of the Picture.** Theatre pictures range in size from, say 6 x 8 ft. to perhaps 18 x 24 ft., or even more in special cases. Thus, their area is between 48 and 32 sq. ft.

Home television pictures range from about 6 x 8 ins. to perhaps 18 x 24 ins. or, in special cases, somewhat more (though generally at the cost of picture detail and brightness). Thus their area lies between about 0.3- and 3 sq. ft.

## TELEVISION IN THE THEATRE

In this, Part II, Dr. Goldsmith continues the discussion of the problems involved in making television practical.

ALFRED N. GOLDSMITH \_\_\_\_\_ PART II

On this basis the area of the theatre picture is about 100-160 times that of the home television picture. A more normal comparison would be with the approximate 30 x 40 in. *home* motion picture, having an area of about 8 sq. ft., or say about 5 times that of the average television picture.

(7) **Picture Brightness.** Theatre pictures are generally adequately bright for viewing in a darkened auditorium (that is, an auditorium with illumination about 0.5-foot-candle).

The television pictures are also sufficiently bright to be viewed in a dimly lighted room—but dark window shades will be required for daylight hours, and for the evening as well if the street lighting outside the home is at all bright.

(8) **Flicker of the Picture.** The theatre picture consists of 24 frames per second, each of which is generally projected twice before the next frame reaches the screen. Flicker is absent, although traces of an effect depending upon picture (Continued on page 362)





# THE EXPERIMENTER'S LABORATORY

The man who aspires to do independent work along any of the numerous lines branching out from the main one of "radio communication" will find some interesting facts in this article for the serious radio experimenter.

C. W. PALMER

**T**HE ENTIRE background of radio advancement is dependent upon experimenting. The early experiments of Hertz, Maxwell, Marconi and Fessenden; the recent research work of Armstrong, von Ardenne, Appleton, van der Pol and others; and the back yard experiments of every radio enthusiast have all contributed their bit towards the remarkable strides which radio has made since its early conception.

The man who assembles a small broadcast receiver in spare time, using his own ideas of layout, circuit, or parts is just as much a radio experimenter as the engineer who spends all his time in the research laboratory. And surprising as it may seem, some of the outstanding inventions—those which have contributed most to the achievement of present-day radio and electronics—have been made by these part-time experimenters, working in their attic or cellar workshops. Take for example, de Forest's development of the vacuum tube, or Edison's discovery of electron flow in a vacuum, or Baird's evolution of the television image transmission—these and hundreds of other important inventions have been the results of experimental work of individuals in "amateur" laboratories.

But so much for generalities—what we are interested in, now, is how to set up a home laboratory. What equipment is needed? How should the individual proceed in the pursuit of his "hobby"? And answers to all the other questions that pop into the mind of a radio enthusiast, whether he is a beginner or veteran, when he starts out to equip his laboratory.

## MENTAL EQUIPMENT

One of the first prerequisites of the experimental lab. worker is proper mental equipment. This includes a knowledge of the subject sufficiently complete so that known phenomena can be recognized and used to advantage. Naturally, the poorly-equipped man will waste much time puzzling over phenomena which are every-day occurrences to the man who keeps on his toes.

This knowledge of the subject can best be obtained from a planned course of study. Schools of both the resident and correspondent types are available and some fine courses of instruction are available. (See the November issue—**VOCATIONAL NUMBER**—of *Radio-Craft* for further information about radio vocations.) In addition to such study, the experimental aspirant must keep abreast of the times. This is best done by carefully following the magazines and periodicals, as all new developments can thus be assimilated. The experimenter should also have a set of reference books as complete as possible. Such a library is invaluable, when a particular idea or phenomenon is being studied.

To be a success in radio engineering work, whether it is along the lines of individual experimenting or in any of the commercial labs., the individual must have a natural inclination and liking for mathematics and physics—this is important!

## LAB. EQUIPMENT

Besides mental equipment, it is important for the embryo experimenter to have sufficient material, tools and equipment to follow up his ideas. This does not mean that he must spend hundreds of dollars on an ideal set-up such as the one listed with this article and shown in the cover illustration. Such a lay-out will only be acquired after years of experimenting. A few tools are essential—and a few instruments such as a voltmeter, milliammeter and an oscillator are needed in almost every experimental set-up. Do not worry about the rest—just gather them as you need them and as your pocket-book will permit.

One thing that the beginner *must* learn, and that is to refrain from making "pretty" chassis with elaborate dials, and similar gadgets when experimenting with a new idea. The old "breadboard" which has served so many times will provide the needed flexibility and permit the innumerable changes that must be made before any new circuit, kink or device is perfected.

(Continued on page 364)

## THE IDEAL EXPERIMENTER'S LAB. SET-UP

### TOOLS AND EQUIPMENT

- Pliers*—long nose; diagonal cutters; heavy end cutters; heavy electrician's pliers.
- Screwdrivers*—heavy broad blade; long shaft with narrow blade; small with insulated shaft and handle; fibre or other insulated type for alignment work.
- Punches*—prick punch; center punch.
- Drills*—round shank twist drills in sizes from 1/16th to 1/2-in.; fly cutter for socket and meter holes; countersink.
- Taps*—in sizes from 4-36 to 10-32.
- Hand drill*—geared type taking up to 3/4-in. drills.
- Brace*—ratchet type taking drills up to 1/2-in.
- Hacksaw*—adjustable type.
- Knife*—with heavy blades for wire stripping.
- Hammers*—small ballpeen type and heavy claw type.
- Files*—flat in several sizes; rat tail; three cornered in several sizes; rasp.
- Vise*—bench type with swivel base and jaws at least 3 ins. wide.
- Soldering iron*—electric preferred.
- Socket wrenches*—in sizes to fit all standard nuts up to 1/2-in. hex. and square.
- Lathe*—bench type with slide rest and assorted chucks, collets, cutting tools, etc.
- Drill press*—with chuck to take drills up to 1/2-in.
- Bench*—with backboard for mounting small tools, electric light outlets, etc.
- File cabinet*—for keeping small parts, hardware, etc.
- Bookcase*—for reference books, magazines and other data.

### INSTRUMENTS

- Voltmeter*—1,000 ohms-per-volt with various scales up to 1,000 V.—or a multimeter made from a 0-1 ma. or 0-500 microampere movement.
- Tube tester*—equipped to test all tubes, including the new metal types.
- V.-T. voltmeter*—for R.F. and A.C. voltage measurements.
- Ohmmeter*—with both high and low resistance ranges.
- Oscilloscope*—with associated equipment—such as a wobbler, amplifiers, etc.
- High-voltage supply unit*—with an output of about 1,000 V. and an adjustable bleeder to take care of all requirements.
- Low-voltage supply unit*—for operating battery tube sets, charge batteries, etc.
- Set analyzer*—this is not essential, unless service work is to be done.
- Oscillator or preferably a "standard signal generator"*—covering all frequencies from 50 to 25,000 kc. in calibrated ranges—and an A.F. modulator calibrated in frequencies from 50 to 15,000 cycles.
- Output meter*—with low and high ranges for intelligent adjustment of radio amplifiers and receivers.
- Storage battery*—for D.C. supply.
- Bridge-type measuring instruments*—such as resistance, inductance, and capacity bridge; decade resistance and capacity boxes, etc., for quantitative test work.

# A SIMPLE "RADIO" "LIE DETECTOR"

The ohmmeter, known to every experimenter and radio man finds a new and novel application.

W. M. HILLEGAS



**T**HE "lie detector" here illustrated and described is used at Cortland Normal School (Cortland, New York), for personal interest rather than its academic electrical value. This makes it desirable that there should be no confusing electrical parts. Even though it has been reduced to a minimum of equipment it is amazingly effective in detecting trivial lies. Aside from its use in the Normal School it has excited great interest at several private parties.

The circuit of the simple galvanometer (milliammeter) and battery is shown here. The appearance of the unit is shown in the photo.

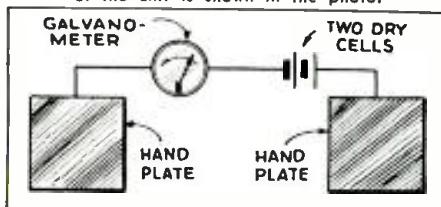

In principle, the lie detector is a "psycho-galvanometer":—that is, it indicates the electrical resistance of the subject's body. This resistance changes in response to emotions, and is beyond the control of the mind. The emotion involved in telling a lie lowers the body resistance, while emotional relief raises it.

The lie detector itself is merely a series circuit involving two dry cells, a moderately sensitive galvanometer, and the body of the subject. (This is similar to the ohmmeters used by many experimenters and Service Men.) Modifications and improvements will suggest themselves to every reader. Contact with the subject is established through two metal plates, about 4 ins. square, upon which he (or she) places the palms of his (or her) hands.

In practice, when the subject places his hands on the metal squares, the galvanometer will read about 20 divisions

on a scale of 30. A slight rise in the reading, even a quarter-point, will indicate the mental activity usually associated with the telling of a lie. Lowering of the reading indicates relief after the lie has been told, or that the question asked did not call for a lie in answer.

Two situations involving lies are easy to set up. In one case the subject is seated at the detector, and requested to pick out one of five cards. The operator is not told which card has been chosen. The operator now shows the cards to the subject one at a time, asking, "Is this the one?", for each of the cards. The subject answers "No" for all of them, thus making only one lie to detect. The operator watches the galvanometer for signs of emotion or relief. With small, serious groups of observers this device will detect nearly all of such lies!

The other sit- (Cont'd on page 357)



**T**HIS receiver kit has been designed to meet the short-wave fans' demand for a sensitive, powerful, and inexpensive receiver that will produce results. Combining these requirements with an unusually-attractive appearance, the S.-W. 5 should satisfy even the most critical short-wave listener. A simple system of band-spreading, in addition to enabling the user to separate the crowded foreign S.-W. stations renders the receiver quite suitable for amateur C.W. station reception.

Three of the latest high-gain tubes—6D6-6F7-12A7, the latter two being of the dual-purpose variety—produce the equivalent of 5 single tubes. An illuminated, airplane-type vernier dial and an unusually smooth regeneration control enable one to bring in those hard-to-get stations with remarkable ease and volume.

\* Eilen Radio Laboratories

## A 5-IN-3 S.-W. EXPERIMENTERS' SET

An up-to-date receiver using dual-purpose tubes to supply the greatest possible signal strength on the S.-W. broadcast bands.

GUY STOKELY\*

Inspection of the circuit diagram reveals the use of the 6D6 tube, V1, as untuned R.F. amplifier. This tube is highly suitable for this purpose and considerable gain is realized from this stage. In addition to this the R.F. stage isolates the detector circuit from the antenna system and thereby does away with the necessity for the usual bothersome antenna series condenser. The antenna circuit is coupled to the grid of the 6D6 by resistor R1 (75,000 ohms).

The output of the R.F. amplifier is coupled to the regenerative detector by electromagnetic means (3-winding coils). The use of this type of coupling results in much greater selectivity than is obtainable from the usual 2-winding-coil method. Primary winding L1 of each plug-in coil offers a high load impedance to the output of the R.F. stage.

The use of grid-leak-grid-condenser detection results in high sensitivity. The detector stage utilizes the pentode section of a 6F7 tube, V2. Screen-grid voltage is varied by means of potentiometer R7, and results in an extremely smooth and noiseless regeneration control. Feedback is accomplished by the third winding in the plate circuit of the detector section of the 6F7. Incidentally, the number of turns in the plate winding is so proportioned that regeneration occurs in that range of screen-grid voltages where sensitivity is a maximum. The bypass condenser C6 (250 mmf.) tends to keep R.F. currents out of the A.F. amplifier. The output of the detector is (Continued on page 366)

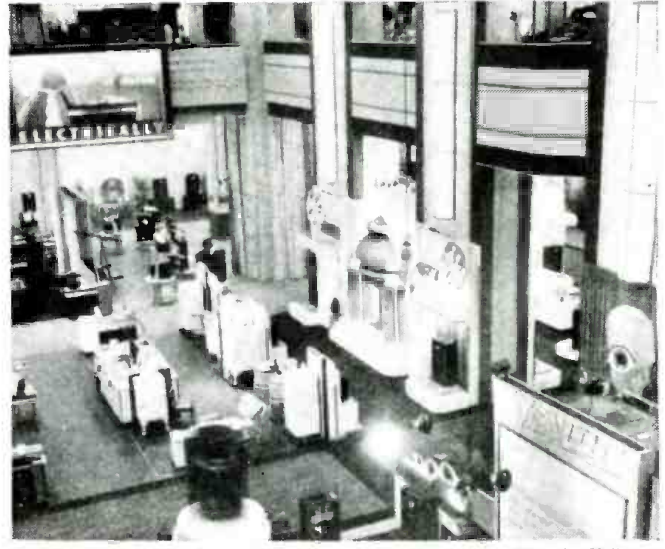

Photo by Halloran

# AT THE NEW YORK RADIO SHOW—

A cross-sectional view of the new devices and interesting displays is given here. Approximately 173,000 people attended this 24th annual show.

**T**HE INQUIRING reporter of newspaper fame found his prototype among inquiring laymen and radio men at the recent Radio and Electrical Exposition in Grand Central Palace, New York. For the artistically inclined, the marvelously attractive treatment of the modernistic motif had outstanding appeal (as the left- and right-wing illustrations in the heading portray); however, there were other attractions to interest more technically-inclined individuals.

The *Radio-Craft* booth was among the foremost of these, but we will

first mention a few other displays of technical interest.

### GENERAL-INTEREST ATTRACTIONS

Before describing the improved apparatus displayed at the Show we will mention a few other points of interest.

One of the most interesting displays illustrated the comparative efficiencies of glass and metal tubes. By means of a 2-way switch and an oscilloscope it was shown that a T.R.F. amplifier became highly regenerative upon substituting glass tubes for metal ones. (See Fig. 1.) Upon the oscilloscope screen appeared a single peak with 10

kc. selectivity when metal tubes were in use.

When the circuit was switched to glass tubes the frequency response became much broader and signal intensity was reduced, three bumps appearing as double-hump resonance developed.

The Hall of Science display of numerous mechanical motions in actual operation was of exceptional interest to experimenters. Talking over a light beam was another attraction that created much comment; (one system for accomplishing this has been described in *Radio-Craft*.) (Continued on page 364)

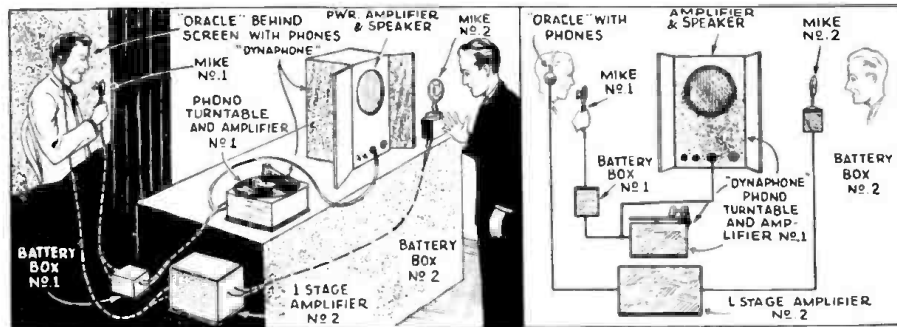

Fig. 2. The RADIO-CRAFT "Oracle Record," as arranged to give replies to any question!

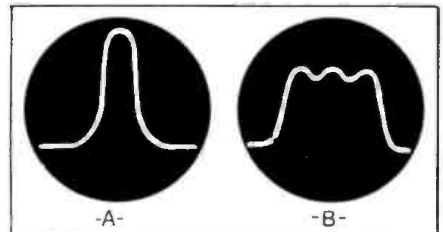
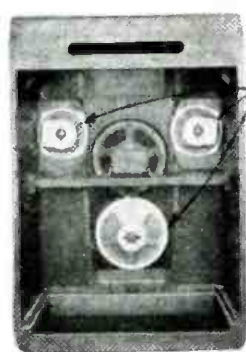
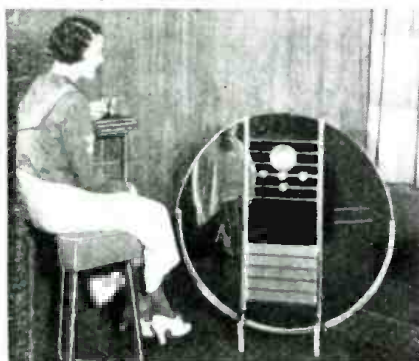

Fig. 1. At the flip of a switch, replacing metal tubes with glass, the oscilloscope screen showed curve B in place of A.

Fig. A. New mirror-panel set.

Fig. C. New "anti-boom" system.

Fig. B. Below, a "Wincharger" (left) powers a set (right).



ACOUSTIC CLARIFIERS

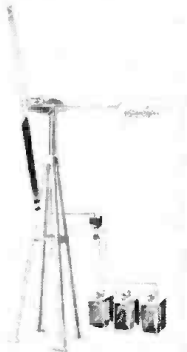

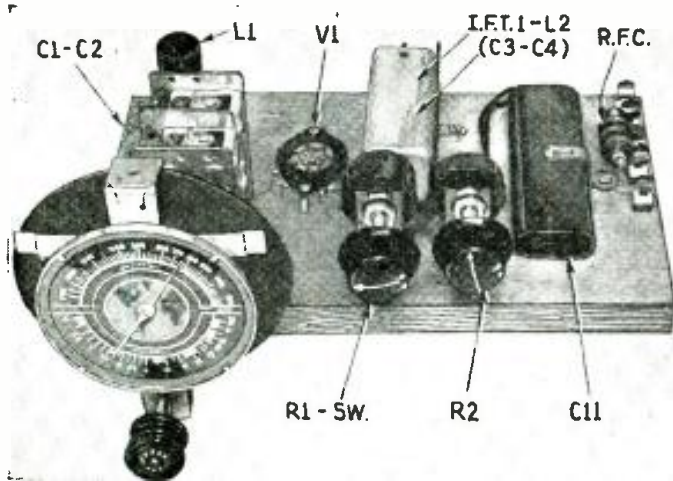

Fig. A. The appearance of the breadboard—during construction.

# AN EXPERIMENTER'S 1-TUBE DOUBLE-REGENERATIVE SUPERHET.

This battery-operated set offers fine possibilities for the home experimenter—who wishes to learn superhet. theory, and at the same time make a fine little set.

R. D. WASHBURNE

**B**EGINNERS and experimenters in radio will be interested in the new circuit arrangement here illustrated and described. The feature of this circuit is that a very efficient means is shown for securing in one tube the functions of (1) a first-detector, (2) an oscillator, and (3) a second-detector—the three essential operations required to produce the simplest form of *superheterodyne*.

A breadboard layout of the major components is shown in Fig. A. The set-up is shown unwired to avoid confusion; the only items not shown are minor components that are connected into place when the circuit is wired in accordance with Figs. 1 and 2.

Previous attempts to produce this particular multi-purpose operation have not been altogether successful. In one instance (See, "How to Make A '1-Tube' Battery-Type Superheterodyne," *Radio-Craft*, April 1935.) for example, the interelectrode electronic coupling tended to defeat the purpose of the circuit, over part of the tuning range.

It will be noted (See Fig. 1.) that the type 6F7 tube has been retained in this newest circuit version (which first appeared in issue No. 88 of *Funk Magazine*, Berlin, Germany) of the 1-tube superhet. However, the sequence of operations through the triode and pentode sections of the tube have been selected more fortuitously, as will be described.

## CIRCUIT SEQUENCE

The incoming or signal-frequency is tuned-in by means of R.F. transformer L1 and condenser C1, and fed to the pentode section of multi-purpose tube V1.

By means of "cathode coupling," local oscillation is produced in the pentode circuit of V1; this circuit is tuned by means of shaped-plate condenser C2, which is ganged to C1.

The resulting I.F. of 456 kc. is fed from primary to secondary of transformer I.F.T.1., and then amplified by the triode-section of V1.

The A.F. output of triode-plate TP is fed to the phones,

or to an A.F. amplifier for loudspeaker operation, as desired.

## DOUBLE REGENERATION

Of exceptional interest is the fact that *double regeneration*—first at R.F., and again at I.F.—is secured by means of certain fundamentally sound artifices, as follows.

Referring again to the input circuit of V1 it will be noted that the third coil marked "tickler" provides regeneration at the signal frequency, as controlled by resistor R1. Since this coil is connected in the pentode-section screen-grid of V1, extremely uniform regeneration is obtained over the entire broadcast band.

A novel means of securing regeneration at the intermediate frequency is afforded by means of condenser C6 and variable resistor R2; this combination serves to feed a portion of the I.F. output of the V1 triode section into the grid-return or "cathode" circuit. Consequently, the pentode section of V1 acts in part to amplify this voltage sufficiently to produce I.F. regeneration, to the degree determined by the setting of resistor R2.

## GENERAL COMMENTS

It is extremely difficult for the beginner, or even the average expert technician to wind suitable coils for really satisfactory operation in circuits using ganged controls, hence, the use of commercially available coils for L1 and L2-I.F. T.1.—as indicated in the List of Parts.

Reverse connections between the arm and one end or the other, of both R1 and R2, for the best "taper" action of each.

Connect the coils as shown in Fig. 2. An improvement in operation may be secured by reversing at X-X, leads 5-6 of tickler coil L1 (which slips inside the secondary). It also may be desirable to reverse at X-X, leads "red" and "1" of coil L2-I.F.T.1.

A convenience to the beginner in set construction is the use of a shaped plate section as (Continued on page 360)

Fig. 1, right. The circuit of the set shows how the one tube is capable of acting as a first-detector, oscillator and second-detector, at the same time. Regeneration is obtained in two places—the first-detector, and the I.F. circuit.

Fig. 2, below. The coil details showing terminal connections for the aerial, oscillator and I.F. windings.

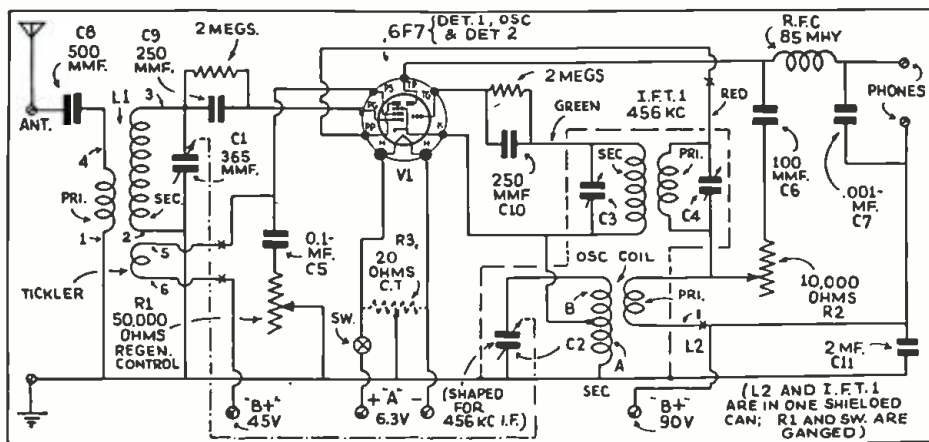
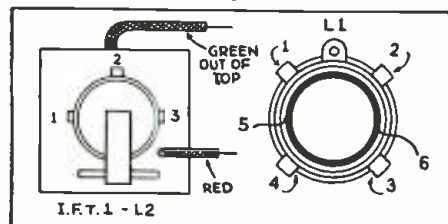



# IMPROVED BOOSTER FOR S.-W. AND ALL-WAVE SETS

This preselector can be used on all types of receivers from small regenerative types to large superheterodynes.

H. B. RUSS\*

**A**N IMPROVED model of the R.F. Preamplifier, which was described in detail in the March, 1935, issue of *Radio-Craft*, is now being marketed for the use of DX listeners, and all others interested in improving the operation of their sets.

The cabinet contains all tuned circuits, with a switch to change the various bands, together with all other necessary elements including a filament transformer. The high-voltage supply is obtained from the set with which the amplifier is used. The connections are very simple, it being necessary only to plug the line cord into a socket, hook the amplifier to antenna and ground, and fasten the set antenna and ground leads to posts provided for them on the preamplifier. The on-off switch on the latter also serves to switch the antenna to the regular set when the extra amplifier is not required. Thus no connections need be changed or removed, once the new equipment has been hooked-in.

The new model is very similar to the original as far as gain is concerned, but the mechanical construction has been improved so that the apparatus is more efficient, and smoother in operation. *Either a doublet or the ordinary antenna may be used*, although the former is much superior for short-wave work. The input circuit is designed to match perfectly with the doublet, while the output matches the antenna circuit of all standard receiving sets.

Other improvements include: new heavy-duty regeneration control; a high-grade, low-loss tuning condenser; band switch with silver-plated contacts; copper-plated chassis to provide better shielding; improved coils of moisture-proof construction.

(Continued on page 363)

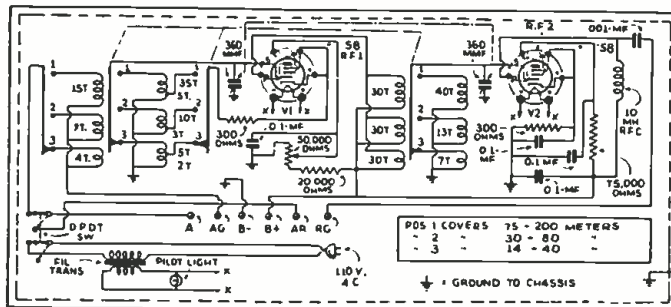

Above, appearance, and below, schematic of preselector.

\*Eastern Radio Specialty Co.

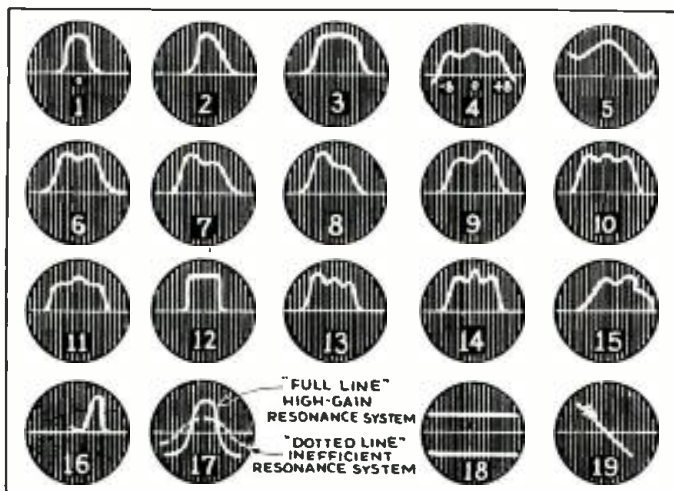

IT IS possible, by carefully studying the resonance curve which appears on the screen of the cathode-ray tube to tell just what the tuned circuit will do to the signal. If, for example, the tuning system cuts off too sharply or its resonance curve is not symmetrical, severe distortion may be introduced in the sound output of the receiver. Once the resonance curve is obtained on the screen, the problem resolves itself into knowing whether or not it is good or bad, and what is wrong with the tuned circuits if the curve is not as it should be.

## FINDING FAULTS VISUALLY

A number of typical oscilloscope curves depicting several different receiver conditions are shown in the illustration in the hope that they will act as a helpful guide in this work. The width of each small vertical space represents 1 kc.

\*Radio Technical Publishing Co.

# INTERPRETING CATHODE-RAY RESONANCE CURVES

A study of images on the cathode-ray screen will tell many things to the advanced experimenter.

ALFRED A. GHIRARDI\*

**Pattern No. 1** shows that the side bands 3 kc. on either side of resonance are cut off. Hence, the tuned circuits represented by this overall curve are unsuitable for high-fidelity reception since the high-frequency response will be poor, although interference will be small.

**Pattern No. 2** shows one side cutting off at 3 kc. and the other extending over 6 kc. The result is that the receiver may be expected to have severe distortion because of the 3 kc. cut-off and interference because of the 6 kc. extension. If the receiver has a diode detector (or any other type of linear detector), distortion will be generated in this circuit because of the asymmetry of the response curve.

**Pattern No. 3** is a nearly perfect response curve of a good receiver (not high-fidelity), since a frequency band over 8 kc. is passed almost uniformly. Selectivity will be good because of the steep sides of the curve.

**Pattern No. 4** illustrates a good resonance curve for high-fidelity reception. It is substantially flat-topped and passes a total band of frequencies 16 kc. wide.

**Pattern No. 5** is not an unusual response curve for an improperly aligned receiver. There is definite overlap into the adjacent channels, which will almost certainly give rise to excessive interference. (Continued on page 367)



# A 10-TUBE SHORT-WAVE AMATEUR SUPERHET.

The experimenter and amateur alike will find this crystal-controlled short-wave receiver to be worthy of the name "communication" set. Details of the features are given.

## McMURDO SILVER\*

**O**F THE receivers available to the serious amateur or short-wave listener, superheterodynes predominate today due to their high selectivity (especially with crystal filters) and their ease and dependability of operation. They are, however almost all alike in that they use but one R.F. stage before the frequency-changer (if any), and the usual and typical crystal filters in a conventional 1- or 2-stage I.F. amplifier. The past year has taught that more can be, and is, desired, as evidenced by the increasing appreciation of the image selectivity and noise elimination benefits of not one, but two R.F. stages; of a quiet, low-gain I.F. amplifier, and stable air-tuned and temperature-isolated circuits throughout.

The receiver illustrated in the heading satisfies these requirements and is described in this article.

The first requirement set up for this design was that it meet the highest standards, in appearance and performance, of the serious amateur. It would then be, automatically, an excellent short-wave broadcast receiver.

For the engineer, its performance is easily described by

\*McMurdo Silver Corp.

mention of its 4 "low-C" (200 mmf.) tuning bands covering 1,700 to 33,000 kc. (which includes the 160-, 80-, 40-, 20- and 10-meter amateur and all short-wave broadcast bands). Its sensitivity is below 1 microvolt over this entire range; its inherent noise never exceeds 10 milliwatts at maximum sensitivity. The selectivity is variable from 150 cycles to 10 kc. at 10,000 times down; fidelity is controllable from flat to 4 db. between 30 to 4,000 cycles, to supply peaked A.F. for C.W. reception; and its undistorted power output is 3.0 W., rising to a maximum of about 4.0 W. Add to this that it has everything but hot and cold running water, and you have the essence of this story!

### ADDITIONAL FEATURES

While considering the really ideal performance described above, let's take a look at its other features as briefly as possible.

**Circuit:** superheterodyne, with two 6D6 tuned R.F. stages on all 4 bands, suppressor-grid injected 6D6 S.-G. first-detector, 76 electron-coupled R.F. oscillator, one 6D6 I.F. stage, high-gain 6C6 tetrode second-detector, 6B7 amplified A.V.C., optimum inductively-coupled variable-pitch 76 beat oscillator, 42

(Continued on page 368)

The experimenter in the field of instantaneous recording should not fail to read this article with extreme care—it contains useful data.

# HOW TO MAKE HIGHER-FIDELITY RECORDINGS ON ALUMINUM

E. A. DENNIS\*

**W**HILE instantaneous recording is not a new art, some concrete advancements have been made in recent years. Experimenters who have not heard some of the latest efforts, may well be surprised at the results now being achieved in this field.

One of the most serious handicaps in the past has been the inability to record the higher-frequency ranges above 3,000 cycles. Several things have been to blame for this condition, and the most serious has been the inability of the various manufacturers to build a cutter flexible enough to operate above 3,000 cycles without blasting, or having the armature strike the pole pieces, causing distortion on the lower frequencies. While this condition has not been completely overcome, there are several rather striking advancements worth noting.

The experimenter will have to overcome part of this trouble in the recording amplifier by the use of filters—or "equalizers" (as they are commonly called). There are at present several

very excellent filters (equalizers) on the market. All of them, however, have one fault in common, namely, waveform distortion on those frequencies that are attenuated, which increases rather than reduces the difficulties of making really good recordings.

Referring to Fig. 1A, it becomes apparent that almost any junk box will yield the necessary parts to construct the equalizer, shown. Condenser C1 should be in the neighborhood of 90 to 50 mmf. Resistor R1 may vary from 1 to 5 megohms, depending upon the amount of attenuation desired. (It is very important that both C1 and

R1 be completely shielded in one can.)

Condenser C1 controls the location at which attenuation begins, while R1 controls the amount of attenuation. The associated amplifier must have a surplus gain of at least 15 db. Under no conditions should this filter be left in the circuit for the playing of a record whether commercial pressings or the instantaneous variety, and while its use is not recommended in recording radio programs, it may be of some advantage where a very high-quality R.F. tuner is used, and even then should be used only on those stations capable of high-fidelity broadcasting.

(Continued on page 369)

FIG. 1—E. A. DENNIS

At (A) is shown the circuit of an "equalizer" for reducing blasting on low-frequency tones. At (B) is a graph of three outstanding factors over the range of 50 to 16,000 cycles.

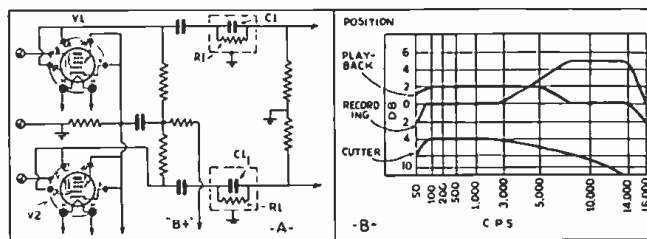

\*Speak-O-Phone Co., Inc.



# HOW TO MAKE A SIMPLE COIL WINDER

Winding "universal" or "honeycomb" coils at home is an accomplishment that most experimenters have tried. This article tells how.

PAUL ROSEKRANS

**P**RESENT-DAY trends in the design of radio sets call for small compact coils of high efficiency. For this reason most manufactured coils are of the "duo-lateral" or "honeycomb" type. Large coils of this type might be wound by hand even though it is a tedious task at the best, but winding small coils of this type presents an extremely difficult task.

The average experimenter often needs special coils of this type which are now available commercially but not to the extent where he can afford to have any considerable amount of money tied up in a winder. The writer being in this class set out to build such a winder out of parts found in that classical reference, the "junk box."

The job of building one of these winders is not at all difficult but there are a number of things to take into consideration. One is the fact that for satisfactory results the construction must be rugged. The whole action of winding must be smooth and even, and the results secured will be a direct measure of the care used in the construction of the winder. End and side play in the various parts must be held to a minimum.

Perhaps the most important single unit in the winder is the cam which controls the feeding of the wire back and forth as the coil revolves. This feed should travel back and forth once while the coil revolves almost one full revolution. Note the "almost" as this is what causes the spacing between turns. This spacing of adjacent turns is what keeps the distributed capacity of the coil low in

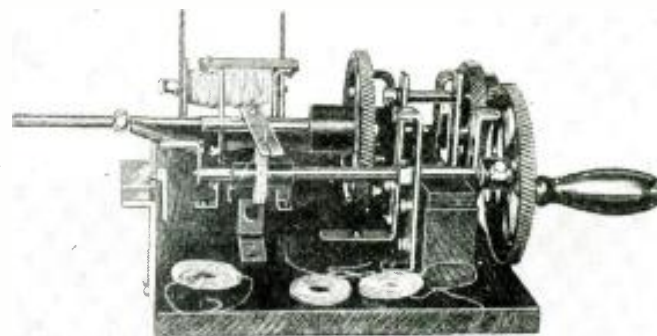

Fig. A. The complete winder with a coil on the mandrel.

value. A feed, back and forth, oftener than suggested above would make for a more substantial coil but would add to the length of wire used for a given number of turns and the slight amount of added stability is not needed. The most important requirement of this feed motion is that it be smooth in its travel; and that it operate at a constant speed, with little or no hesitation at either end.

## CAM DETAILS

Figure 2A shows the constructional details of this cam. Note that it is made from an old tube base, and the ease and simplicity of the construction make it possible to have cams on hand for most any width of coil desired. If many coils are to be wound it might be well to make the cam from metal but from our experience it seems that the tube base will suffice in most instances. As will be noted (Fig. 2B), a paper template is first made. Then with glue or rubber bands it is placed around the tube base, making sure that the bottom is evenly spaced from the bottom of the tube base. With a rat-tail file, the bakelite can be cut down to the template. A smaller, finer file can then be used to finish the cam. It should not take over 30 minutes to complete the whole job. The bottom of the base furnishes an excellent means for mounting as it should be mounted on a plate of some sort. In the writer's winder an extra gear which was at hand was used for this mounting plate. This made it easier to assure having the plate perpendicular to the shaft all around. Bolts through the tube base, tapped into the plate or bolted through the plate may be used, but be sure to center the cam on the plate.

Another requirement in the design has been mentioned before, that of having the coil revolve slightly slower than the cam. This can be done obviously by making the gear which drives the shaft upon which the cam is mounted slightly smaller than the one driving the shaft on which the coil is wound. The individual constructor may be as fussy as the "junk box" will allow in this respect but in the winder described, the larger gear is 4½ ins. in dia. and the smaller one is 4 ins. in dia. This gives a satisfactory coil but other diameters will do just as well. A gear ratio of about 15-to-14 would be ideal, but 15-to-12 will also be satisfactory. (Because the two large gears used did not mesh directly it was necessary to add a driving gear between the two.)

Figure 1 shows the entire layout in better detail than the photograph. Special attention is called to the method of getting satisfactory bearings. Probably this feature is the hardest to fulfil in the entire construction. In the winder here described some brackets from old open-core transformers were at hand and were used. They are ⅝-in. wide and 1/16-in. thick. Each pair is clamped together and drilled for the shaft, also two extra holes are drilled for bolts which clamp the brackets to pieces of wood 1¼-ins. thick. Depending on the care with which these operations are completed, we have in effect a bearing 1⅜-ins. in length. The whole assembly should be screwed to the base as securely as possible. (The small driving gear is not shown in Fig. 1 as it would only complicate the drawing.)

The various parts are labeled in the diagram but to make things more clear, Fig. 2C is given to better show (as an example) the construction of the bearing against the cam and the connection (Continued on page 371)

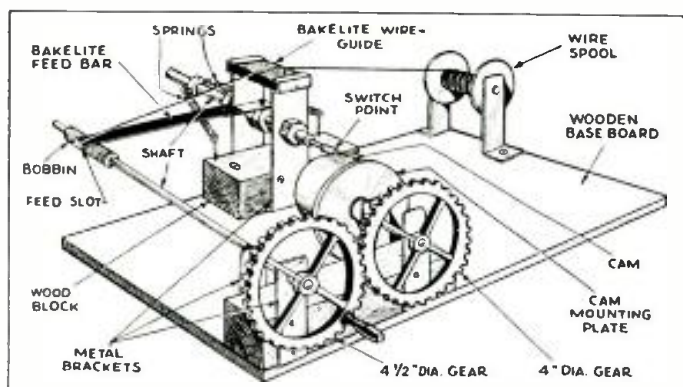
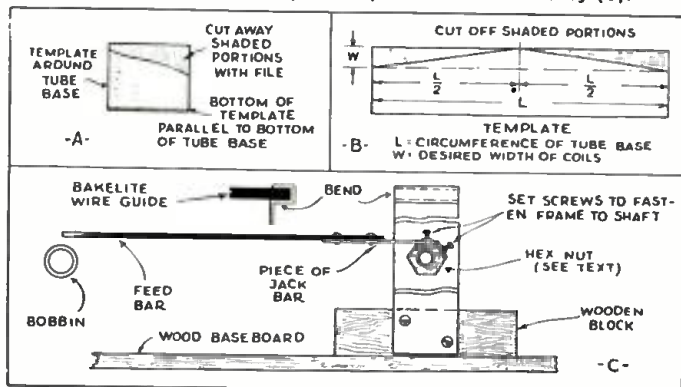
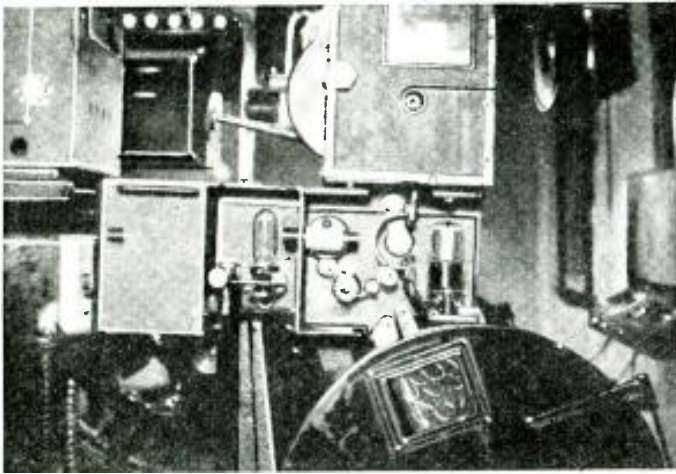

Fig. 1. The mechanical layout of the winder parts.

Fig. 2. Cam construction (A and B) and feed-bar mounting (C).





A typical sound head shown schematically in Fig. 1.

# SERVICING THEATRE SOUND SYSTEMS

The sound head is discussed in this, Part I; and other components in subsequent parts. (See, also, the 5-part [Feb. '30, etc.] and 7-part [Nov. '33, etc.] talkies articles.)

A. V. DITTY

PART I

**T**O THE radio Service Men and the projectionists who are occasionally or actively engaged in "Talkie Service," the need for information of this sort is apparent. While it is not entirely feasible to deal with specific cases, the author will attempt to supply the readers with information of a general kind so that it may be of aid to them in meeting the ever-rising problems of sound service.

The few remaining "sound-on-disc" installations are fast becoming obsolete, presenting no great difficulty in servicing them should the occasion arise. (Considerable data concerning the service angle of sound-on-disc has appeared in past issues of *Radio-Craft*.—Editor.)

The sound head is the heart of the "talkie" system (Fig. 1.). This consists of a housing frame (containing the exciter lamp, optical barrel, photoelectric cell, and film-driving mechanism), which is mounted on the projector base between the projector head and the lower magazine, or the "take up" magazine.

The function of the sound head is to take the sound off the film (Fig. 2.). This is accomplished by driving the film through the sound head in such a manner that the condensed rays of light from the exciter lamp, narrowed down to .001-in. by the optical barrel and varied in intensity according to the variations on the sound track, impinge upon the photo-cell, which in turn sets up variations in current in the primary circuit of the preamplifier. Improper adjustments and alignments will ruin the possibility of creating the "perfect illusion" by producing distortion in music and voice.

## SOUND HEAD DRIVING MECHANISM

The first thing we will consider is the speed of the driving mechanism of the sound head. Various types of sound heads are driven by different methods, all of which have good and bad points from the operator's consideration, but with which we will not be concerned.

The object of any driving mechanism is to obtain a fixed speed on the drive shaft through the sound head. Most sound heads are equipped with flywheel arrangements or governors to maintain constant speed in order that the sound will not be impaired by fluttering.

The film, traveling at the rate of 90 ft. per minute, with 16 frames per ft., will give a speed of 1440 frames per minute. The sprocket on the drive shaft will take 4 full frames per revolution; and by dividing the number of frames per minute by the number of frames per revolution of the sprocket, the correct speed of the drive shaft is found to be 360 r.p.m. The speed may be easily checked by means of a tachometer applied directly to either end of the drive shaft. A film speed indicator, attached to the projector head shutter shaft, reading 90 ft. per minute is another way of checking the speed, although not as accurate as the tachometer method.

With machines that are running too fast the sound pitch will be raised, introducing a "tinny" or "nasal" quality, making it harsh and shrill. Machines running below the rated speed will create a "boomy" tone which is noticeably lower in pitch and entirely lacking (Continued on page 370)

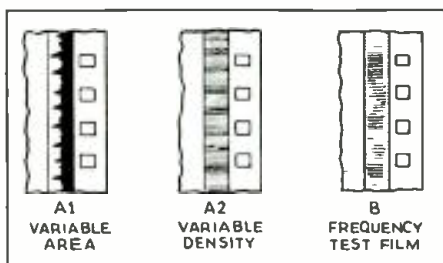

Fig. B. Sound head of RCA high-fidelity set-up.

Fig. 2, left. The two types of film sound recordings used and a strip of "frequency test" film.

Fig. 3, right. An oscillator-type exciter lamp supply unit (A); and a view of the optical barrel and optical system.

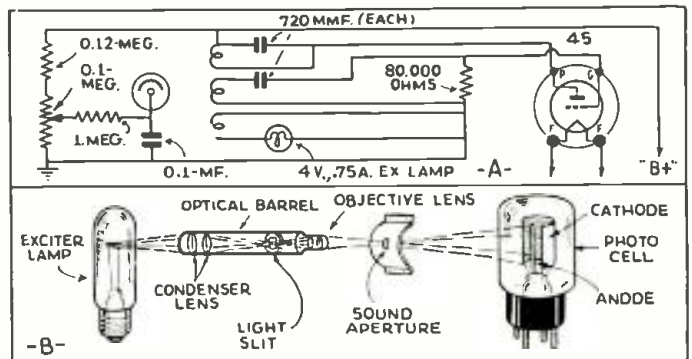
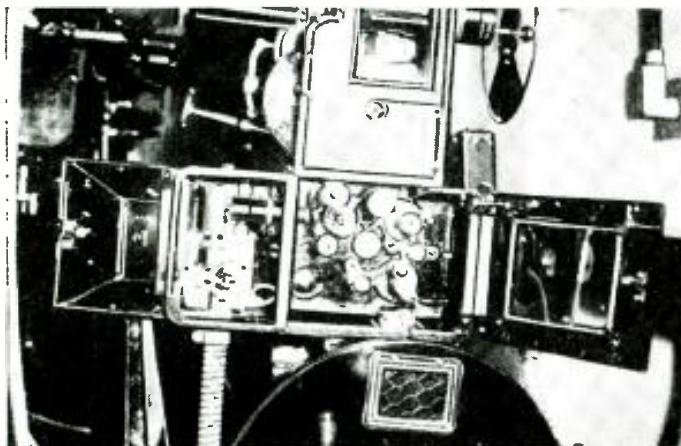
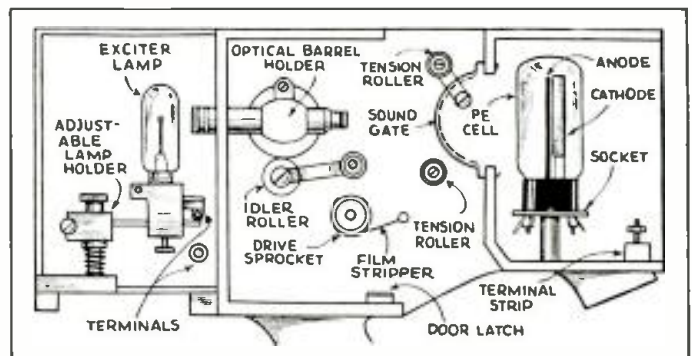

Fig. 1, below. Positions of the parts in the sound head.



# ELECTRONICS AIDS "BEHAVIORISM" TESTS

Amplifiers and electronic "triggers" make possible this device which many experimenters will find interesting.

ORMAL I. SPRUNGMAN

**W**HY DO some individuals learn more quickly than others? What part does heredity or environment play in determining whether a person will become a good or poor learner?

This is the problem which Prof. William T. Heron, psychologist at the University of Minnesota, is attempting to solve. To carry out his 7-year ex-

periment, Prof. Heron designed and built the automatic rat maze shown here, believed to be the only one of its kind in the world. (The idea of course has many other applications.)

The unique device consists of two rotating tables, housing 54 white rats in separate compartments, and 12 Y-shaped connecting units of the maze containing runways and "blind alleys." A small motor, geared to a Ford axle mechanism, which supports each of the tables, moves a new compartment into position in front of the runway as soon as the preceding rat has passed through the maze. An empty compartment awaits the animal at the end of each "run."

Once every day each of the 54 rats starts up the runway, steps upon two tiny plates of monel metal and records his movements on a specially-built, motor-driven typewriter in another room. The minute amount of current

(Continued on page 374)

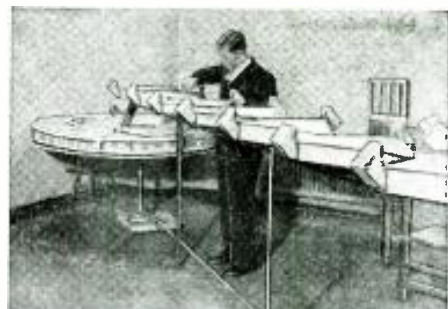

Fig. A—The rat maze with its 12 passages.



Fig. B—Prof. Heron with part of the maze.

Fig. 1—One of the V-T. triggers which actuate keys of the typewriter recording the rat's movements.

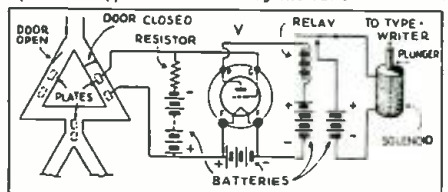

Fig. C—Close-up showing one unit of the maze.

## HOW TO EQUIP A SOUND TRUCK FOR ELECTIONEERING, ETC.

With election day fast approaching, there is a real demand for high-power sound trucks.

CHARLES R. SHAW\* PART II



**O**NE OF the most valuable adjuncts to a sound truck is a reproducing and recording unit for making of special advertising records, speeches of famous orators, or other special sound effects. The portable P.A. demonstrator described in the July 1935 issue of *Radio-Craft* will prove to be of great value to any sound car. Can you imagine how valuable such a recording system can become during the forthcoming political campaign, wherein presidential candidates speak for themselves (through recordings) at all political gatherings?

Hundreds of precautionary and safety measures can likewise be effectively "broadcast" by Voice of Safety cars through city streets.

Of course, these auxiliary accessories need not be added to the sound truck installation unless their usefulness makes them necessities for the contemplated installation.

### RACK AND PANEL CONSTRUCTION

In a system specifically purchased for permanent installation in a sound truck, all of the equipment should be

\*Columbia Sound Co., Inc.

mounted on rack panels and placed within the car at some position convenient for operation either by the driver or the announcer.

While the installation of sound equipment in theatres and similar indoor places presents difficulties due to the necessity for placing the horns in such a manner that the architectural features of the space will not be marred, the sound truck usually does not present such a critical problem. As a matter of fact there are many approved methods for mounting the speakers into a sound car. Naturally the exact procedure depends upon (a) the type of speakers

(Continued on page 374)

The rear of the amplifier shown above. The various sockets used for connections can be seen. This amplifier is well planned for election P.A. work.

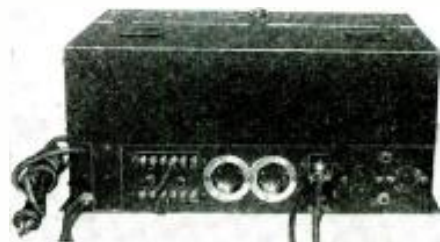

# THE PHOTO-CELL IN THE EXPERIMENTER'S LAB.

Useful experiments and circuits for the PE. cell, additional to those in the April, 1935 issue of *Radio-Craft*, are described here for the radio technician and experimenter.

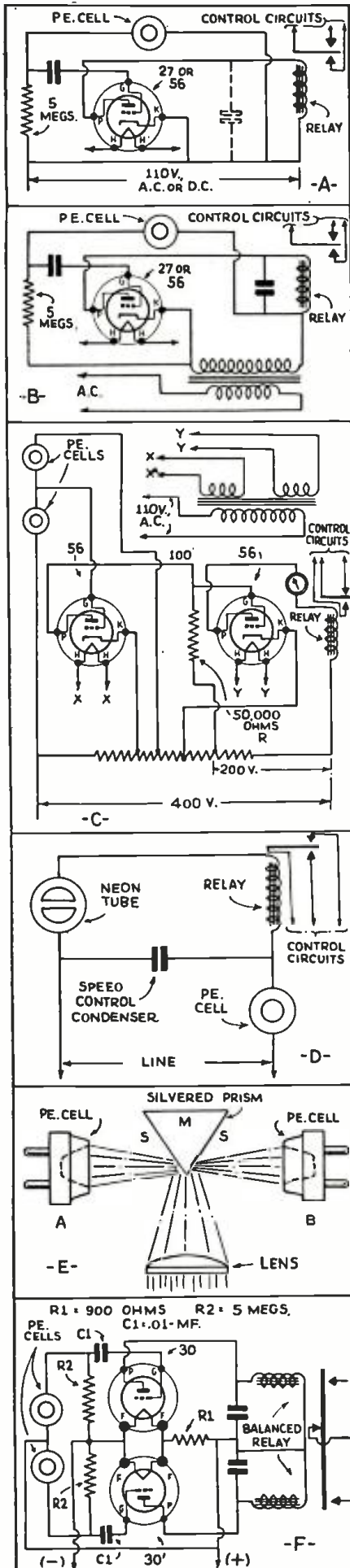

FOR SOME YEARS past, engineers and laymen alike have been hearing many rumors as to the almost magical potential uses of the photoelectric cell, more generally known as the "electric eye." Within recent years, many of these potential uses have been achieved in actual practice!

We see doors swing mysteriously open at our approach; see homes and business houses equipped with modern "light beam" alarms. And, if we go farther, we find the electric eye controlling factory illumination, counting products or people, sorting colors, insuring proper development of films, and so on. Thus, it has already found a definite and important place in the world of today.

These uses, however, represent only a bare beginning. Interesting and useful as they are, they only scratch the surface of future possibilities. Vast and startling advances will undoubtedly be made in the not-far-distant future. As one well-known electrical engineer has aptly remarked: "Name me your industry or business and I'll show you where the photoelectric cell may soon be playing an important part in it as we learn to adapt its vast potentialities to specific needs."

Some time ago a practical joker in a large western city, according to the story, wanted an unusual watchdog to stand guard in front of his house. Already possessing a mute metal mutt, he equipped it with a big raucous buzzer and adjusted the magnet armature to emit a ferocious growl-like sound. Then, to make the paralyzed pup "watch," he rigged up a photoelectric relay, in such a way that it would scan the sidewalk leading to his house. As a result, when visitors approached, they were startled by growls, for in walking up the sidewalk they interrupted a beam of light focused on the electric eye and thus actuated the relay which, in turn, energized the magnetic voice.

Although the ferrous "friend of man" was not equipped for tail-wagging, hand-licking, or the performance of other characteristic traits of a bona-fide pet, the owner, it is understood, was very well pleased with his growling "robot Rover."

## A SENSITIVE CIRCUIT

A practical experimenter's circuit for using a PE. cell is shown at A in

Fig. 1 (at left); it is a "trigger" arrangement and is suitable for operation on either A.C. or D.C. No gridleak is provided, and there is no necessity for maintaining any particular potential on the grid; the grid assumes its own negative potential. Many authors on vacuum tube operation are inclined to discredit stability on the part of the grid. Actual trial of this hookup is convincing of the fact that it is the most sensitive combination possible to obtain with any three-element tube! If used on A.C., a condenser must be shunted across the relay to prevent chatter, but if used on D.C. this is unnecessary. Figure 1B shows the same circuit for A.C. operation, only.

When two or more stages are used, the tubes must be coupled together, thus there must be a means for transferring the energy from the plate circuit of the first tube into the grid circuit of the second tube. There are 3 types of coupling employed, namely, resistance coupling, transformer coupling and direct coupling.

## A DIRECT-COUPLED AMPLIFIER

An example of direct coupling is illustrated in Fig. 1C. It will be noted that the plate of the first tube is connected directly to the grid of the second tube, therefore, the potential of the plate will maintain the potential at the grid of the second tube at this same value. The various voltages employed are taken from the voltage divider shown. The proper voltage conditions on the elements of both tubes must be maintained.

Supposing that the plate of the first type 56 tube receives its potential from the mid-point of the divider, which is 200 V.; resistor R then serves as the plate load and its value should be about 50,000 ohms. The potential of the plate will then be approximately 100 V. (100 V. drop in potential existing across the resistor R). The grid of the second tube also has a potential of 100 V. The grid bias of the first tube is taken directly from the voltage divider. The characteristics of the type 56 tube are such that the cathode should be approximately 15 V. positive with respect to the grid. Since the grid of the second tube is at 100 V. potential, the cathode is then connected to the voltage divider at approximately 115 V., which will be on the negative side of the plate tap for

(Continued from page 376)

# ANNOUNCING THE WINNERS IN RADIO-CRAFT'S "IDEAL RADIO SERVICE SHOP" CONTEST!

"Congratulations to the winners in this contest! I wish also to compliment not only those whose exceptional entries earned Honorable Mention, but all participants; every contestant exhibited an earnest desire to aid manufacturers in seeing the Service Man's needs in test equipment, that is sure to be soon reflected in improved designs of new testing apparatus for service work of all types."

Signed, JACK GRAND, DIRECTOR

**T**HE JUDGES aver that the highlight of the contest was, as one judge phrased it, "the battle of the Sayres" for First Place; coincidentally, both contestants live in the same state—and within 15 miles of each other!

There were over 1,500 entries in this contest, with winning positions allocated as follows:

**1st Prize**—E. E. Sayre, 33 Union Ave., Maplewood, N. J. Awarded: RCA No. 9545 Portable Cathode-Ray Oscilloscope (Net \$84.50).

**2nd Prize; and Special Manual Prize No. 1**—Theodore R. Sayre, 1136 Woodruff Ave., Hillside, N. J. Awarded: Weston Model 663 Volt-Ohmmeter (and carrying case), (Net. \$48.75); and, a Gernsback Consolidated Official Radio Service Manual (Net. \$17.50).

**3rd Prize**—John Litwin, R. R. No. 1, Fletcher, Ontario, Canada. Awarded: Hickok Model OS 7 All-Wave Service Oscillator (Net, \$48.00).

**4th Prize; and Special Manual Prize No. 2**—Dexter M. Royce, 17 Arch St., Laconia, N. H.

Awarded: Supreme Model 333 DeLuxe Set Analyzer; or (optionally), Supreme Model 85 Tube Checker (in either Counter or Portable model, and improved to test metal tubes), (Net \$39.95); and, a Gernsback Consolidated Official Radio Service Manual (Net, \$17.50).

**5th Prize**—Kenneth E. Hughes, 2115 44th St., Galveston, Texas. Awarded: Clough-Brengle Model UC Portable Vacuum-tube Voltmeter (Net, \$34.80).

**6th Prize; and Special Manual Prize No. 3**—Stephen DiMayo, 1412 W. 5th St., Brooklyn, N.Y. Awarded: Triplett No. 1200 Multimeter, and No. 1220 Free-Reference-Point Tester, (with No. 1202 2-section carrying case), (Net, \$34.67); and, a Gernsback Consolidated Official Radio Service Manual (Net, \$17.50).

**Special Manual Prize No. 4**—Robert C. Hannum, 512 Hannibal St., Fulton, N.Y. Awarded: a Gernsback Consolidated Official Service Manual.

**Special Manual Prize No. 5**—J. D. Wilhoite, 1745 Lawrence, Memphis, Tenn. Awarded: a

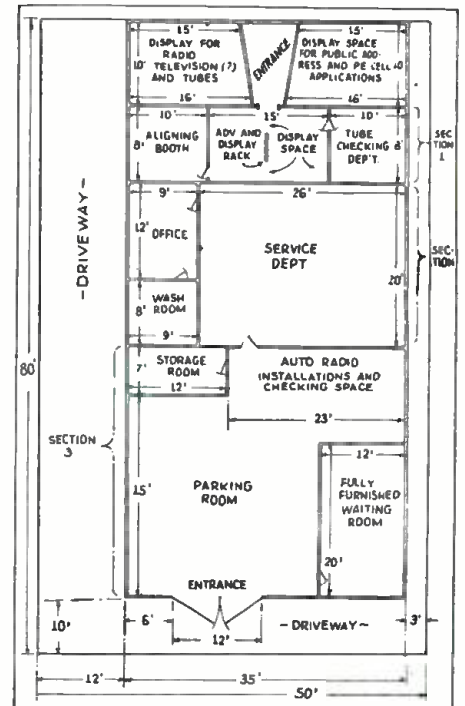

Second Prize Winner T. R. Sayre (Hillside, N.J.) chose to illustrate his entry.

Gernsback Consolidated Official Service Manual. **Special Manual Prize No. 6**—Leslie E. S. Pass, 1225 Second Ave., Worthington, Minn. Awarded: a Gernsback Consolidated Official Radio Service Manual.

(Continued on page 372)



Above, a complete Midwest receiver. Below, a close-up of the dial and control-panel, which incorporates novel features.



## 80 FEATURES IN THE NEW 18-METAL-TUBE SET!

The following features of a modern radio set afford an excellent example of the progress in radio receiver design.

W. A. SMITH

**M**ANY radio listeners and engineers have expressed a desire to know just what are the 80 features advertised for the new 18-tube Midwest set which was shown pictorially and by diagram in the October, 1935, issue of *Radio-Craft*. We are pleased to present the following tabulation of the features of this interesting set, in the belief that it will be of interest to the radio public in general.

The tabulation has been divided into three divisions, although the division must, of necessity, be rather arbitrary.

### MECHANICAL FEATURES

No. 1—The front panel is of heavy steel. The appearance of walnut finish is obtained by a photographic process, the finish being of tough lacquer.

No. 2—Escutcheon is of heavy chrome-finished metal; colored inserts enhance the beauty.

No. 3—Stations can be found by frequency, since the dial is completely calibrated; most lists now use this system.

No. 4—A line of light eliminates error in station selection. The exact center of the band-indicator is marked by the light (Line-O-Lite).

No. 5—A positive mechanical drive on the dial provides extremely smooth tuning, without backlash.

No. 6—A spot of light (Spot-O-Light) travels with the selector switch, to indicate the band in use.

No. 7—The dial is simplified and the tuning

centralized by the use of concentric knobs so that no auxiliary verniers are needed.

No. 8—Various classes of transmissions are grouped and marked by name on the dial for ease of operation.

No. 9—Chrome-plated streamline control levers are self-indicating as to their positions.

No. 10—Low-loss porcelain coil forms and "litz" wire contribute to eliminate image-frequency reception and heterodyne interference.

No. 11—Special porcelain is used for the R.F.-section coil forms, to enable them to be pressed into the aluminum frame under high pressure; this construction eliminates many nuts and bolts, assuring a rigid unit.

No. 12—The 86 pieces of porcelain in the set assembly insure high insulation at all times.

No. 13—Small parts are all fastened to lug's and not merely supported by the wiring.

No. 14—The special 4-gang condenser is mounted on sponge rubber pads, and fully shielded.

No. 15—Special reinforced socket-bakelite greatly reduces breakage.

No. 16—Discs of alba-fibre in the I. F. transformers keep the leads in position and stabilize the gain.

No. 17—Oversize A.F. transformers provide high energy transfer at low frequencies.

No. 18—Loudspeaker leads, by terminating in a plug, provide for easy removal.

No. 19—The oversize power pack obviates over-

(Continued on page 379)

# HOW TO MAKE A SENSITIVE RELAY UNIT

The experimenter in radio and electronics often has need for a sensitive "primary" relay, for PE. cell and radiodynamic work—here is a dandy! The "secondary" relay—for the power circuit—also is described.

E. L. DEETER

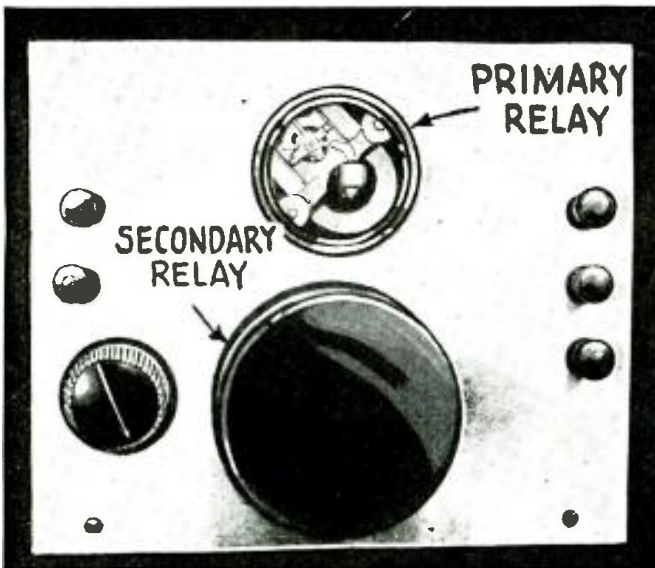

Fig. A. The complete relay unit with sensitive relay and secondary relay in place.

IN THE experimental electronic field frequent need is found for a sensitive "primary" relay that will operate on small currents and pass sufficient current at the contact points to close a larger and more rugged "secondary" relay. Many circuit requirements cannot be fulfilled by the use of the conventional single-pole magnetic relay; instruments of this type usually possess a high resistance and require over a milliampere of current for operation. The more sensitive relays are expensive, of intricate construction and hard to duplicate by the experimenter who wishes to build his own.

A sensitive relay of the meter type (so called because it's construction resembles a current-registering meter with points on the vane) can be constructed at low cost, from parts usually found in the shop of the radio man or experimenter, as described in this article. Such an instrument will close contact on 500 microamperes and operate a secondary relay handling up to several amperes.

The sensitive relay of the unit described here is constructed from a current-indicating meter capable of showing full-scale deflection on 5 milliamperes or less. The meter used by the writer was a Jewell voltmeter, type 135, used quite generally in the days of the type 99 and 01A tubes as a filament-current meter. The same model often had a dual scale registering both "A" and "B" volts. In either case, the moving coil of the meter was

standard and had a resistance of 5 or 6 ohms, a series resistor compensating for the various voltage scales.

With the series resistance or coil out of the circuit these meters will give full-scale deflection on 5 ma. (There are many thousands of these meters lying around in junk boxes and radio stores—why not have a good milliammeter by removing the series resistance and calibrating a new scale?)

A good many experimenters have, no doubt, attempted the construction of a relay from a meter, invariably finding that it was no task for a novice. While a stationary contact is easily arranged, it is a delicate operation to place the necessary contact on the featherweight vane—not an easy matter even for an accomplished jeweler.

## EARLY EXPERIMENTS

The writer carried on some experiments to see just what could be done along these lines. A length of silver wire was placed across the sweeping path of the vane which was scratched clean on the contacting edge. A load of 4 ma. was placed in series with the points. With 2 ma. through the meter contact at first was secured, but after about ten times contact was lost or became faulty, the cause being diagnosed as too much current at the points (even after making allowance for the fact that the vane metal was not ideal as a contact metal). With reduced current at the contacts, the results were better, but then, the current handled by the-points was no more

than the current required to deflect the meter. Believing that the instrument might be a success if the contact current was low enough, a circuit was arranged whereby the points closed an open grid circuit to a tube, therefore carrying an infinitely small amount of current, the idea being to place the secondary relay in the plate circuit of the tube. Even this failed to produce satisfactory results, the pressure required on the vane sometimes bending it.

In attempting to solve the contact situation, the idea of using *metallic mercury* (quicksilver) for one of the contacts was investigated, with gratifying results. With the vane bent so as to pass the point into a cup of mercury, the operation obtained was satisfactory in every way and the writer constructed the unit shown pictorially, the construction of which is described in the following paragraphs.

## THE "PRIMARY" RELAY

Having secured a meter of the type mentioned, proceed to dismantle the instrument for remodeling. Two small screws directly back of the flange and opposite one another are removed, allowing the cover-glass and rim to be lifted off. Remove the three countersunk screws at the back of the bakelite case and loosen the leads on the interior with a hot soldering iron. The "works" may now be taken from the case. The "start" and "stop"

(Continued on page 375)

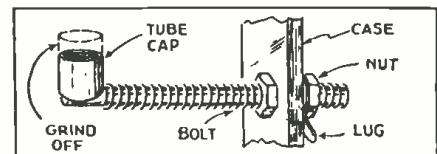

Fig. 1, above. The mercury contact.

Fig. 2, below. The circuit of the unit.

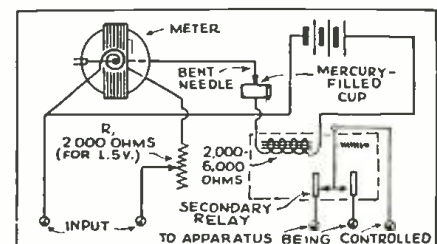
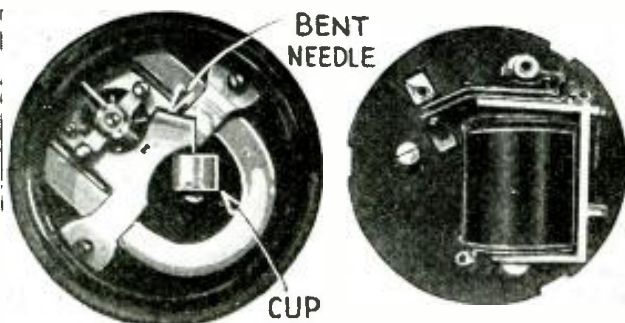

Fig. B, extreme left. The parts of the sensitive relay can be seen in this photo.

Fig. C, left. The construction of the secondary or high-power relay is shown in this detail view.



# HOW TO ADD HIGH FIDELITY TO OLD SETS

The detector and audio amplifier play an important part in the achievement of real high fidelity—here are some circuits and data especially written for the experimenter.

WILHELM E. SCHRAGE

**S**INCE the first article concerning high-fidelity design published in this magazine some time ago, tremendous strides have been made in the construction of these new receivers. Some manufacturers who insisted, not so long ago, that only a few radio listeners would be interested enough to pay the relatively higher price for sets of this kind, have changed their minds entirely, and are now very busy pressing their design engineers "like lemons" to complete their work!

## HIGH OR LOW FIDELITY?

The author recently visited New York's radio district around Cortlandt Street, and, in a well-known radio shop, tried one of the displayed receivers, proudly marked as a high-fidelity one. The result of this listening test was a big surprise. There was a remarkable lack of the "lows" in the reproduction, and the highs over 5,000 cycles, which the writer knew were being transmitted by certain stations, did not show up at all. Briefly said, the reproduction of this "wonder set" was not better than other receivers sold a few months before without that valuable advertising

slogan: High Fidelity.

This incident shows impressively how careful one has to be in all matters concerning high-fidelity receivers to avoid disappointment, since the definition "high fidelity reproduction," does not have direct legal protection, although an indirect protection is given by the definitions of the Radio Manufacturers Association concerning high fidelity, and also through the systematic definitions published by the well-known design engineer, Stuart Ballantine, in the *Proceedings of the Institute of Radio Engineers* during the past year.

## OFFICIAL DEFINITION OF "HIGH FIDELITY"

According to the RMA definitions, a high-fidelity receiver, for a given uniform input, should not fluctuate in power output more than 5 db. in the range from 50 to 7,500 cycles. That means in more simple language: "a receiver with a peak in the range exceeding 5 db., or with a similar valley in the response curve (a volume-change which is readily discernible to the average ear) cannot be marked as a

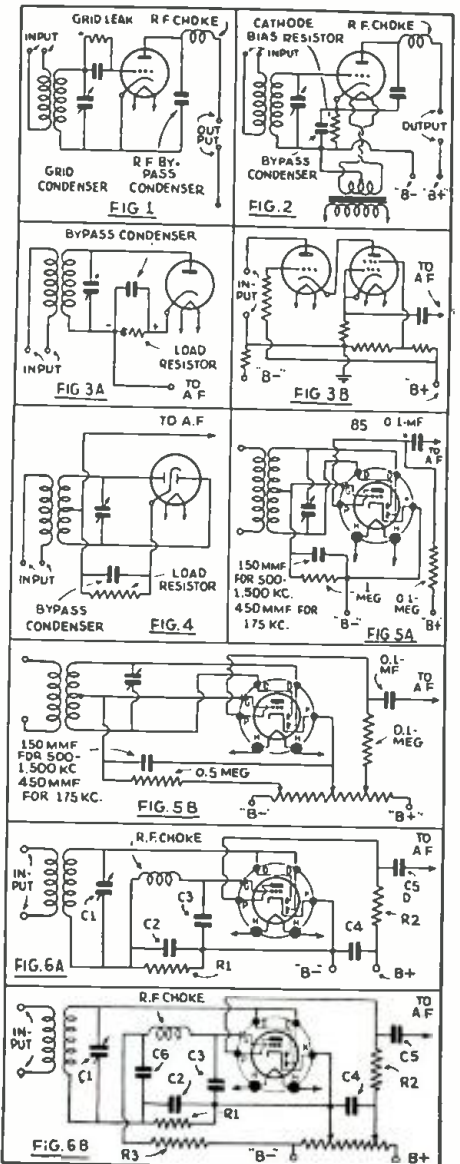

Figs. 1 to 6—detector arrangements.

high-fidelity one. Such a set should be described or marked according to Table I only as a "medium"-fidelity one.

Table I

Uniform response within 5 db.	Uniform response within 10 db.	Correct description of receiver.
50-7,500 cycles or above	—	high fidelity
100-4,000 cycles	—	medium fidelity
—	50-7,500 cycles	medium fidelity
200-2,000 cycles	—	low fidelity
—	100-4,000 cycles	low fidelity

(Continued on page 381)

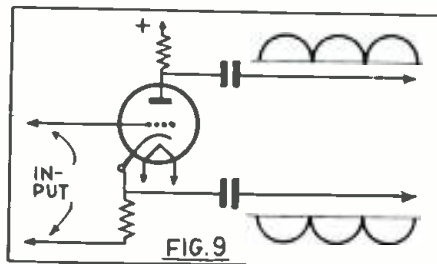
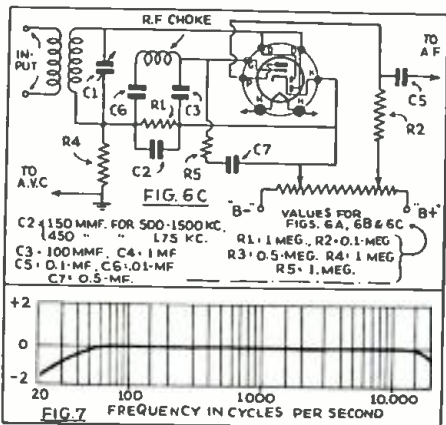
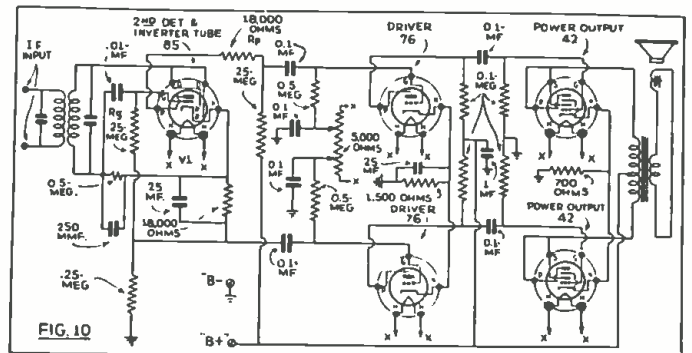
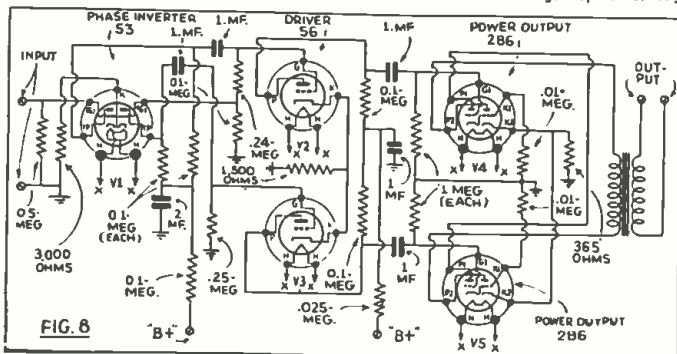

Fig. 9, above—the way in which phase inversion is obtained with only one tube.

Figs. 6C and 7, left—half-wave detector with triode fixed bias; A.F. response curve.

Fig. 8, lower left—resistance P.-P. amplifier.  
 Fig. 10, lower right—simplified amplifier.





# A PRECISION BRIDGE-TYPE CONDENSER ANALYZER

The experimenter and Service Man will find innumerable uses for this versatile condenser-test instrument.

S. A. WOLIN\*

**A**S AN invaluable aid for the Service Man and experimenter in detecting leaky, shorted, open, off-capacity and intermittent defects in condensers this scientific analyzer will fill a long-felt need. This instrument will quickly determine the quality of all paper, electrolytic, and mica condensers.

The capacity range, which extends from .00002- to 70 mf., is read directly, after visible balance of the "Wien" bridge circuit is obtained by the indication of a thermionically-controlled neon glow tube. This is more convenient and much more accurate than the use of headphones for balancing.

The use of this precision analyzer for testing the dielectric resistance of cables, insulators, and between trans-

former windings, as well as a power factor indication, makes it even more useful to the laboratory worker and experimenter.

This tester is a combination of two devices: (1) a capacity bridge; and, (2) a direct-current leakage tester.

## THE CAPACITY BRIDGE

The capacity bridge consists of the usual 4 arms; two are resistors (the ratios of which are varied by adjusting knobs S1), and the other two are condensers (a standard, and the unknown). The instrument is provided with 3 standards selected by the switch S2 and corresponding to the three calibration scales of the

instrument; at position 4 resistor R2, in series with the highest capacity standard, improves the balance when testing high-power-factor electrolytic condensers.

The A.C. voltage source for the bridge is obtained from P.T. secondary Sec. 1. The detector arms of the bridge are connected to the control-  
(Continued on page 365)

The circuit of the "bridge" test instrument with the neon-type leakage tester.

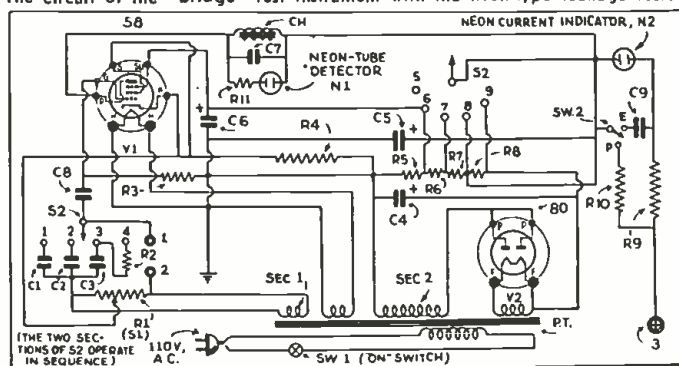

\*Solar Manufacturing Corp.

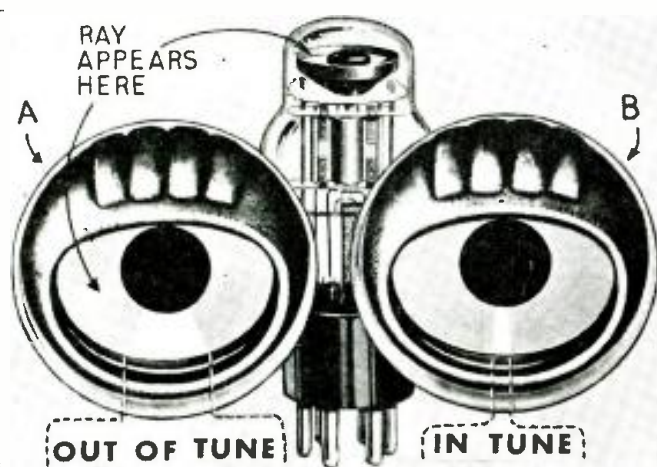

# HOW THE 6E5 CATHODE-RAY TUNING TUBE WORKS

This new tube, a visual tuning indicator, has no moving parts! Greater detail is here given, than when first announced in the Sept., 1935 issue of Radio-Craft.

Fig. A. "Target" of tuning tube; the width of shadow cast by the ray-control electrode varies.

Fig. 1, below. The schematic symbol of the 6E5 tube connected to the output of a 6H6, V1.

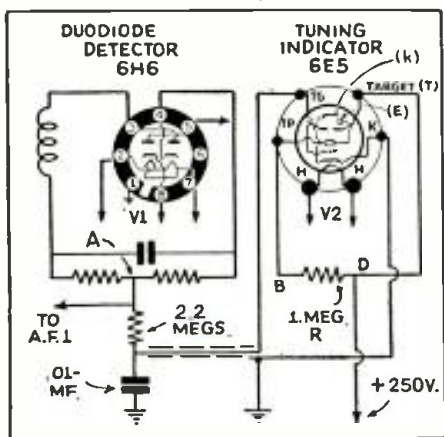

**T**HE 6E5 tube, the new visual tuning indicator that has no moving parts, is really two tubes in one, as the upper part acts like a cathode-ray tube while the lower part acts as a triode! The cathode is common to both sections of the tube. A rough idea of the internal construction of this unique tube, developed by RCA Victor laboratories for use in the 1935-'36 line of radio sets, may be had from the schematic symbol of Fig. 1. The triode is used as an amplifier, as will be explained later.

The cathode-ray is produced as follows. When the cathode is heated, electrons given off in the upper end (k) are attracted to coated target T operated as a positively-biased anode.

(See Fig. 1.) When the electrons (constituting a "cathode-ray") hit the target its coating glows or "fluoresces" with a greenish-yellow color. The electrons leaving cathode K at tip k and being drawn to the positive target, can be controlled and directed by a third element, E, called a "ray-control electrode" (see Fig. 1).

The operation of the visual indicator section of the tube depends on the control which the ray-control electrode can exercise over the area of the target which is struck by these electrons. The pattern (in the 6E5, the impression of an "eye" is created, the pupil being simulated by a light-shield placed at the tip of cathode k) developed on the fluorescent target depends on the contour of the target as well as on the potentials, position and shape of the ray-control electrode. When a receiver incorporating the 6E5 is tuned  
(Continued on page 378)



FIRST PRIZE.....\$10.00  
 SECOND PRIZE.....5.00  
 THIRD PRIZE.....5.00  
 Honorable Mention

EXPERIMENTERS: Three cash prizes will be awarded for time- and money-saving ideas. Honorable mention will be given for all other published items. Send in your best "kinks"!

# SHORT-CUTS IN RADIO



Fig. 1. A novel burglar alarm made from a "dimmer."

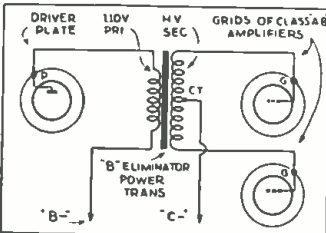

Fig. 2. Emergency transformer for class AB amplifiers.

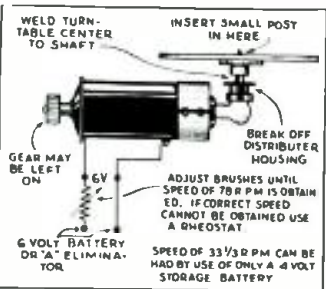

Fig. 3. Phonograph motor made from a "chevy" generator.

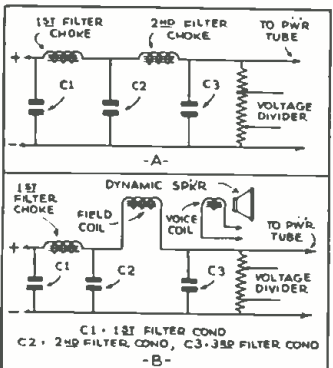
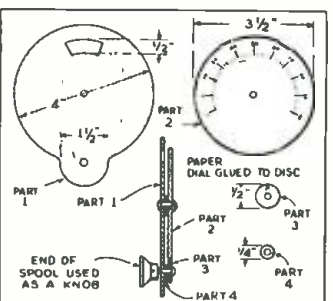

Fig. 4. At A, first circuit; B, after installation of new speaker.

Fig. 5. Home-made vernier dial for the "Distance Getter for \$1."



## FIRST PRIZE—\$10.00

**BURGLAR ALARM.** This arrangement was rigged up after our radio store was robbed, to prevent a similar occurrence. The night light is lit by using a long stick with a hook to pull the chain of the ceiling socket. If the cord hanging from the night light is pulled, the large bulb lights and remains lit, and the horn blows continuously. They cannot be turned off, since the relay locks in and must be manually released! The night light socket is changed so that the switch shorts the 10-W. lamp, thus closing the circuit for the 100-W. lamp and horn, and the relay. See Fig. 1.

A. B. DUNGAN

## SECOND PRIZE—\$5.00

**EMERGENCY TRANSFORMER** for class AB amplifier. The power transformer from almost any make of old "B" eliminator, will serve as a very efficient input transformer for a class AB amplifier. The transformer must, of course, be one that has a center-tapped high-voltage secondary. Those taken from a Majestic Super "B" work very well. The secondary has ample carrying capacity for the grid current on positive peaks. See Fig. 2.

LANDO K. MOYER

## THIRD PRIZE—\$5.00

**PHONOGRAPH MOTOR.** This motor is made from junk parts, but works very well. It is made from a Chevrolet generator, and is used for both recording and playback work. There is plenty of power available and the unit may be used in a sound truck very nicely, since it operates on 6 V. The only real work to be done is to break off the distributor housing and weld the turntable to the shaft. Any speed may be obtained by adjustment of the rheostat. See Fig. 3.

JOE YEAGER

## HONORABLE MENTION

**REPLACING OLD SPEAKERS.** There are many old A.C. sets in use today, whose owners would like to have the advantages of dynamic speaker results, but can't afford new sets. Figure 4 shows how this can be accomplished on the old sets, without much change being necessary, yet the results are very satisfactory. The field of the new speaker is put in the circuit as a second choke. The transformer on the new speaker connects directly to the posts which formerly

Fig. 6. Special trimmer wrench.

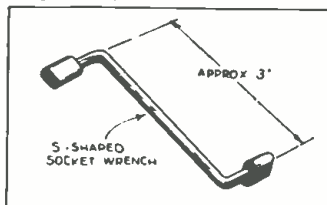

went to the magnetic speaker. If the new field causes too great a voltage drop, run the high-voltage lead from the output tubes to the connection between the field and the choke.

WM. CLARK

## HONORABLE MENTION

**HOME-MADE DIAL.** When building the "Dollar Distance Getter" (*Radio-Craft*, March 1935), I decided it needed a real vernier dial, so I built a condenser like the ordinary variables, and made the dial, shown in Fig. 5, to go with it. The material consists mainly of cigar box wood and a spool. The paper scale can be hand-drawn or cut from a radio catalogue illustration.

CYRIL STATT

## HONORABLE MENTION

**HANDY WRENCH.** Certain old models of Victor radio sets have a special oval head for which a wrench was made, but these wrenches are no longer available. The use of pliers on these screws is very apt to damage them so that they cannot be moved. The body of the wrench is made of 3/16-in. rod, 5 ins. long. The ends may be made from 30 A. copper lugs, or copper tubing from an auto gas system. They are formed by carefully hammering the piece over one of the screw heads, until a snug fit is obtained. Two similar pieces are needed, but make them so that the flat part of the slots will be at right-angles in the finished wrench. The job is finished by soldering the ends to the handle. See Fig. 6.

J. M. WALLACE,

Mimico, Ont., Can.

## HONORABLE MENTION

**AUTO RADIO MOUNTING.** By mounting an auto set on a strong metal plate, and then fastening the plate to the dash-board with a single large bolt, considerable time can be saved. Most of the auto sets have three or more mounting bolts, and it is often a tough job to drill all these holes in the dash. Also the bolts on the set sometimes come in the wrong place and a part of the car has to be moved, to make the installation. All this trouble is saved by the above method, and the set can be quickly moved for service. See Fig. 7.

O. J. COOMBS

(Continued on page 378)

Fig. 7. Easy auto-radio mounting.

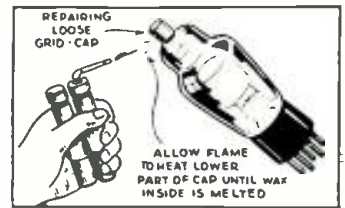
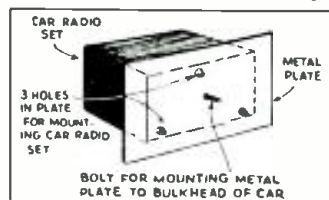

Fig. 13. Replacing grid cap.

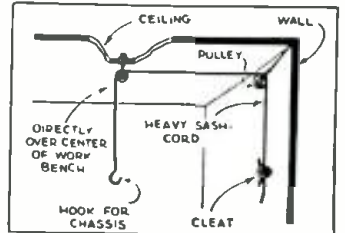

Fig. 12. Chassis holder.

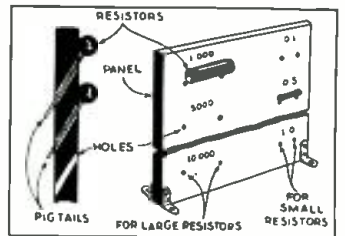

Fig. 11. Resistor panel.

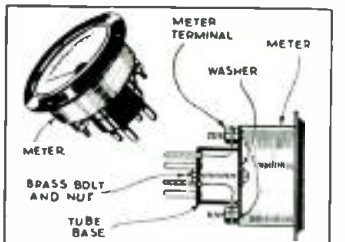

Fig. 10. Plug-in meter.

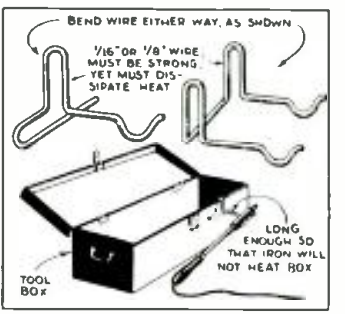
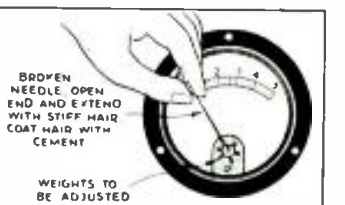

Fig. 9, above. Soldering iron holder.

Fig. 8, below. Repairing meter pointer.



# THE LATEST RADIO EQUIPMENT



"Automatic" analyzer. (849)

## NEW "AUTOMATIC" ANALYZER (849)

(Supreme Instruments Corp.)

A TESTER which works so quickly and easily that it is called "Automatic" is illustrated. It combines a tube tester and a complete analyzer in one compact unit. Resistance: 200 ohms to 20 megohms, in 6 ranges. A.C.-D.C. voltage and current: 5, 25, 125, 250, 500, and 1,250 ma. Capacity: .05-mf. to 12.5 mf., in 6 steps. Metal and glass tubes are tested at rated load.

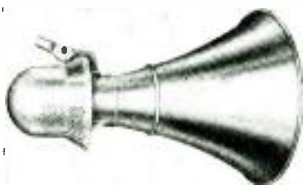

Dynamic horn. (850)

## TURRET PROJECTOR (850)

(Racon Electric Co.)

THIS weatherproof dynamic speaker horn is especially suitable for outdoor use, as it is completely weatherproof. Specifications: The speaker itself is a special broadband speaker unit, 10 W.; field (requires separate exciter), 18 W. Finish, battleship gray. A sturdy mounting bracket is supplied. Two types of bells—termed breakable, and aluminum—are available.



Improved P.A. outfit. (851)

## HI-POWER AMPLIFIER (851)

(Columbia Sound Co.)

THIS versatile amplifier can be used on 110 V. A.C., or on 6 V. D.C. (as described elsewhere in this issue). Two 25 W. output channels are available. Input accommodates (with ample gain) 2 carbon "mikes" or 2 pickups, and 2 crystal or ribbon mikes, simultaneously. Metal tubes are used in the first voltage amplifying stages. A special speaker matching system is a feature. Hum level is exceptionally low.



Lapel crystal mike. (852)

## CRYSTAL LAPEL MICROPHONE (852)

A LAPEL microphone of crystal type is now available. Weight, 1 1/2 ozs.; size, 5/8-in. x 2 ins. dia. Clips to coat lapel. Operating output, -65 db. Finish is rubber-black japan overall.

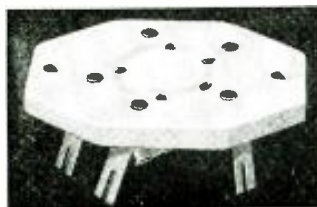

Above, improved socket. (853)

Below, vacuum-tube voltmeter. (854)

## ISOLANTITE SOCKET (853)

(Hammarlund Mfg. Co.)

A NEW method of prong anchorage eliminates loosening of contacts. The isolantite is treated to prevent absorption. A "guide-groove" speeds tube insertion.

## V.-T. VOLTMETER (854)

(Weston Electrical Instrument Co.)

A COMPACT vacuum-tube voltmeter is now available, with a range of 1.2 to 16 V., in 6 ranges. The instrument is de-



New metal-tube set. (855)

## COMPACT RADIO (855)

THIS set features 5 metal tubes and "control room reception." It has a 3-position tone control, A.V.C., and vernier dial. Two tuning ranges: 540 to 1,712, and 2,300 to 7,500 kc. Six tuned circuits provide high selectivity.

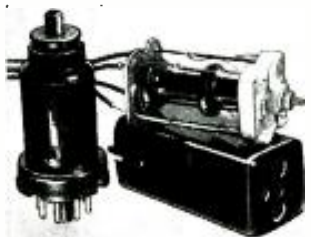

Iron-core I.F. transformer. (856)

## IRON-CORE I.F. TRANSFORMERS (856)

THE CORES of these new I.F. transformers are made of finely-divided iron particles, insulated from each other by a special compound. The resultant material is moulded into forms which closely resemble solid metal. The transformers are of very small size, but are said to be as efficient as large air-core types.



Headphone adapter kit. (857)

## HEADPHONE KIT (857)

ANY SET may now be adapted to headphone operation, with the minimum of trouble, by the use of this new kit. Includes a power tube socket adapter, a jack box, and a pair of special lightweight phones. The kit may be used with either single or push-pull output stages.

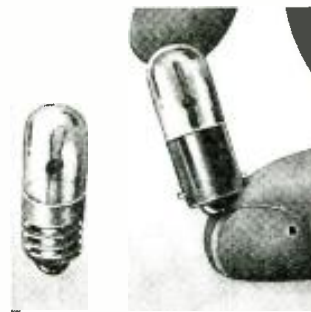

Bayonet-base dial lamp. (858)

## BAYONET-BASE PILOT LAMPS (858)

BAYONET bases are supplied on the newest pilot lamps for radio set use. Unlike screw-base lamps, bayonet-base bulbs do not loosen. Available in all types.



Above, resistor broken to show construction. Below, size comparison. (859)

## MIDGET RESISTORS (859)

TINY insulated resistors (shown in comparison with a paper clip) are now made which are rated at 1/4-W., although they will carry as high as 1/2-W. They are not only color coded in the standard way, but also may be had with an additional code line to indicate tolerance of accuracy. The resistor element and its end caps are enclosed in a ceramic shell (as illustrated). They measure only 3/16- x 7/16-in. long.



## 3-SPEAKER HIGH-FIDELITY A. F. SYSTEM (860)

ALTHOUGH this 2-section amplifier system was designed primarily for use in theatre work, it is very versatile, and can be

Name and address of any manufacturer will be sent on receipt of a self-addressed, stamped envelope. Kindly give (number) in above description of device.



A 3-speaker, 40-10,000 cycle theatre and P.A. system (A, left; B, right). (860)

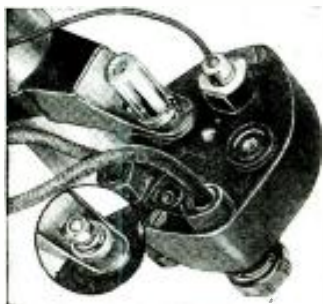

Thief-proof locks. (861)



Ultra-tiny panel lamps. (862)

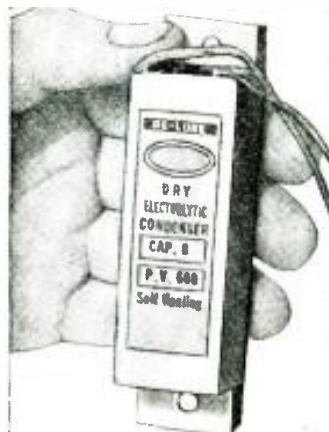

New electrolytic condenser. (863)



Above, adjustable resistor. Below, useful small-size relay. (864)

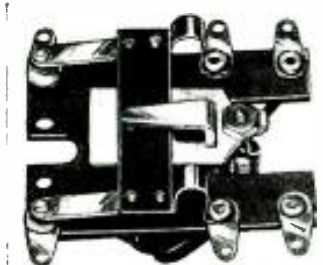

used for all sorts of P.A. requirements where performance is more important than cost. The equipment comes in 24 different models, for houses from 500 to 4,000 seats. A preamplifier is not required. Fader, tone control, and other controls are built-in (B); outfit is suitable for all types of film and exciter lamps. A tweeter, and two medium-to-low-range reproducers (A) afford flat frequency response from 40 to 10,000 cycles.

### PORTABLE LOCKS (861)

THESE unpickable locks are made in many sizes and types. One is illustrated on the rear of an autoradio control head. The lock is said to defy hammer and cold-chisel. An inexpensive means of protecting from theft anything that can be bolted in place.

### MINIATURE BULBS (862)

THE EXPERIMENTER will find wide application for these 2.5 V. tiny bulbs. They are obtainable both with and without bases, tiny sockets being supplied for the former, as illustrated. Many uses will be found for these units in models, instrument lighting, etc.

### SELF-HEALING CONDENSER (863)

ALTHOUGH its peak voltage rating is 600, this entirely dry, long-life unit will heal itself after surges as high as 3,000 V. The 8 mf. unit shown measures 3 x 1 1/4 x 7/8-in. thick.

### 2 USEFUL UNITS (864)

TWO VERY useful units that meet many needs of the experimenter are available from one manufacturer, and are described as follows.

#### VARIABLE RESISTOR

This resistor is suitable for applications requiring low resistance and a large capacity. Made in 21 adjustable sizes from 1.7 to 178.2 ohms, and from 100 to 30 W. (respectively). Resistance value is variable in 19 steps; the slider then locks in position.

#### SMALL RELAY

This relay was designed for use in radio shops, etc., for individually connecting one of several sets to a single antenna, the set's filament current operating the relay. May be used in numerous experimental set-ups, too.

### SOUND PROJECTOR (865)

(S.O.S. Corp.)

THIS portable sound-movie and P.A. system is completely self-contained, and designed for 16 mm. sound film operation. Amplifier and speaker are housed in separate boxes. Amplifier panel carries PE. cell voltage, volume and tone controls. Gain, 110 db. (eliminating need for a pre-amplifier).



Sound movie outfit. (865)

### AIR TRIMMING CONDENSERS (866)

BOTH single and double units are available in 16 capacity ranges from 7 mmf. to 110 mmf., maximum. Available with fixed padding sections. Isolantite insulation.

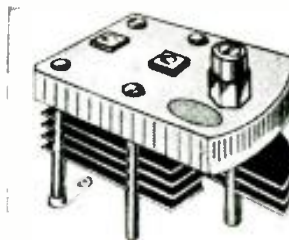

Air dielectric condenser. (866)

### ANTENNA TUNER (867)

(The Muter Company)

THIS unit is said to increase volume and selectivity, and reduce interference and static at all wavelengths. It is used with a doublet antenna, and functions to tune the antenna to the wavelength being used. Two tap switches permit adjustment to the most efficient setting.



Antenna tuning unit. (867)

### CONDENSER KITS IN USEFUL CONTAINERS (868)

(Tobe Deutschmann Corp.)

THESE kits come packed (at no extra cost) in a handy metal cabinet, which may be used for many purposes, after the contents have been used. The condensers are of the best construction, and are first-class units. The cabinets may be fastened together to form a solid unit.



Handy condenser kits. (868)

### STICK-TYPE RESISTORS (869)

A RESISTOR which can be broken into three separate sections, if desired, and used in any combination with other units or alone, is illustrated. The wire, nickel-chromium alloy with chrome-oxide enamel, is close-wound. Available in 3, 5, and 10 W. sizes, and many standard resistances.



Above, combination resistors. (869)  
Below, economical tester. (870)

### LOW-PRICED OHM-METER (870)

(Radio City Products Co.)

A COMPACT, low-priced instrument for measurement of ohms, volts, and milliamperes is illustrated. Scales: 0-1,000-100,000 ohms; 0-2.5-125-750 V.; and, 0-5-100 ma. Measurements down to less than 1/4-ohm may be made. (Tester is available without the volts scales at a slightly lower price.)



### METAL-TUBE SET (871)

EIGHT metal tubes are used in this latest console set. It is a 5-band superheterodyne, with A.

(Continued on page 373)

WELLS-GARDNER 5 E SERIES CHASSIS (MODEL 25E1 AND 25E5 SETS) 5-TUBE BATTERY SUPERHET.  
(Class B output; high sensitivity; band-pass antenna circuit; batteries contained in cabinet.)

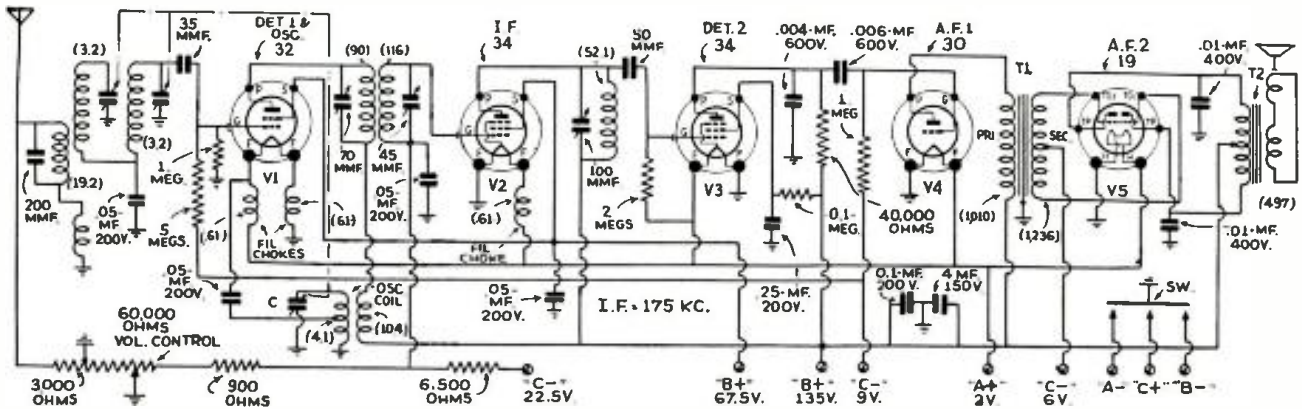

The following voltage table is correct when the antenna is shorted to ground and the volume control is on full. All readings are made with a 1,000 ohms-per-volt meter.

Tube	Fil.	Plate	S.-G.	C.-G.
Type	Volts	Volts	Volts	Volts
V1	2.0	135	67.5	7.5*
V2	2.0	135	67.5	2.5**
V3	2.0	50	40*	0
V4	2.0	135	—	9***
V5	2.0	135	—	6

\*with 250 V. scale; \*\*with 25 V. scale; \*\*\*read at "C" battery. All voltages read to chassis. Power output is about 1 W.

The first I.F. transformer is of the fixed-tuning type, while the second is of the impedance type, tuned by a trimmer condenser. A non-metallic screwdriver should be used on this as it is at "B" positive potential. Connect the signal lead from the oscillator (which has been set at 175 kc.), through a .05-mf. condenser, to the control-

grid of V1, and align the I.F. trimmer located at the back of the chassis. Then set generator at 1,730 kc. and attach lead to antenna post of receiver to align oscillator section of 3-rang condenser. This is the one with cut plates. Set the signal generator at 1,400 kc. and turn the set tuning condenser for maximum volume. Adjust the other 2 trimmers for highest volume. The dial may be accurately set for calibration by tuning to a station at 800 kc. and setting the dial pointer at that position.

If the set does not work well and the batteries are known to be in good condition, check the tubes carefully, especially the type 32 tube, as they sometimes vary in characteristics enough to cause trouble. Should the circuit oscillate or whistle when first connected up, the ground lead should be checked.

When the "B" batteries are replaced, the "C" batteries also should be changed, since

the "C" drain is such that they both run down at about the same time. The set is designed for use on a 2-V. storage cell, but by use of a variable series resistor of 3 ohms and a voltmeter connected to the terminals of the set, the 3-V. bank-type of dry battery may be used although the resistor must be gradually increased, to compensate for the drop in battery voltage. The filaments should never be run at a higher voltage than 2.1, while if they are run at less than 1.8 the quality will suffer. The "B" battery drain increases when the volume control is advanced higher than about two-thirds. Also the drain increases as the signal becomes greater.

In some locations a short antenna will give satisfactory results, but if possible it should be 100 to 150 ft. in length for best results.

Distorted reception is often the result of incorrect battery voltages, and these should always be carefully checked before doing any work on the set.

ECHOPHONE MODEL C 6-TUBE A.C. BROADCAST BAND MANTEL SET

(This set is said to be the forerunner of all the present day "mantel-type" radio sets.)

The Echophone Model C "Mantel" set probably is the forerunner of the deluge of midset sets. This set sometimes bears the nameplate of the manufacturer, "Ufonic" or "Echophone." Of particular interest is the method of securing regeneration in the detector, V3. Radio frequency current is taken from the detector plate and fed through condenser C to the primary of the R.F. coil, T4. The 2,500 ohm potentiometer, shunted across this primary, controls the amount of feedback. The tuning section is best lined up at 1,200 kc., with the regeneration control at minimum.

To service the set, remove the volume and regeneration controls from the front panel. At the rear, remove all the wood screws (only). Pull out the back slightly, and unsolder the speaker leads. Tighten all the mounting bolts and make a visual inspection for broken leads and defective wire-wound resistors. Trouble frequently will be due to loose or bent tube-socket prongs. A material increase in sensitivity and decrease in hum may be obtained by substituting a 56 for the 27 tube. Bypassing R2 may improve the A.F. quality.

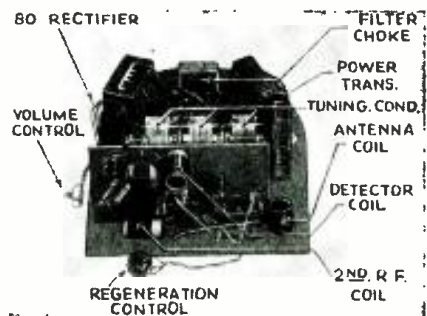

The circuit of the set showing the peculiar regeneration control.

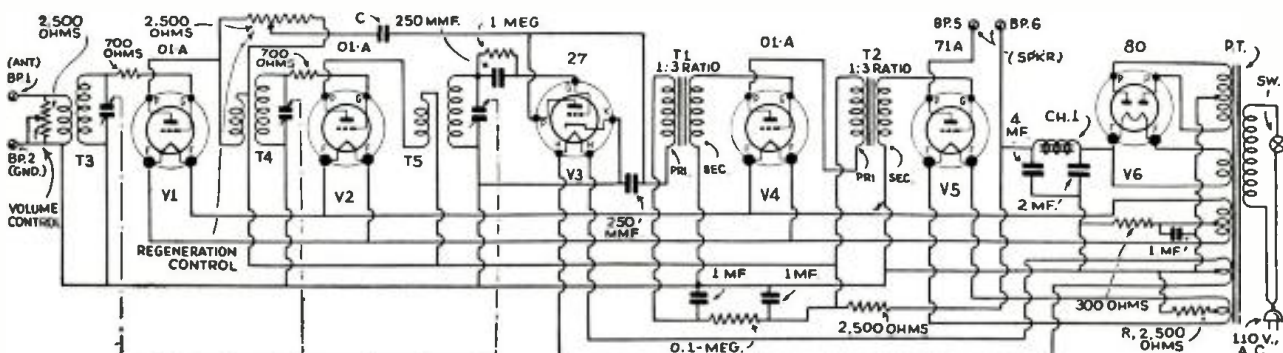

## AMERICAN-BOSCH MODEL 595, 10-TUBE, ALL-WAVE SUPERHETERODYNE

(Four bands, 120 kc. to 18,500 kc.; variable selectivity intermediate transformers; "Centr-O-Matic" tuning unit; 10-W. output; metal tubes; tuning meter; special audio input circuit; power consumption 90 W.)

When testing, do not leave the chassis on its side or top as the electrolytic condensers may leak through the air vents. Screws X, Y, and Z, on Fig. D hold sections of the Centr-O-Matic unit in place; each section is removable.

**Adjustment of I.F. (465 kc.)** The I.F. trimmers are adjusted only when the variable selector coils are placed in a particular mechanical position. The travel brought about by the expander mechanism is limited by definite stops and the circuits are so designed that the sensitivity of the receiver changes very little from maximum selectivity to maximum fidelity. In order to align the circuits properly, use less coupling than that provided by the maximum selectivity setting.

To obtain this lesser coupling merely remove the self-tapping screw (indicated by "W" in Fig. D) which acts as a stop to limit selectivity. Further procedures follow.

- (1) Turn vol. control full on; connect output meter across voice coil.
- (2) Feed a 465 kc. service oscillator signal to grid of V5 through .5-mf.
- (3) Adjust trimmer No. 76 to max. output.
- (4) Feed to grid of V4; adjust Nos. 63 and 65 to max.
- (5) Feed to grid of V2 first detector; adjust Nos. 54 and 56 to max.
- (6) Turn selectivity control to extreme right and replace the stop-screw. (During subsequent adjustments, turn it to extreme left.)

### Adjustment of Purple Band.

- (1) Service osc. and dial indicator, 350 kc.; test signal to ant. through 200 mmf.; adjust Nos. 36, 28 and 8 to max. Then, reset to 130 kc. and adjust No. 45.

- (2) Oscillator and dial indicator to 130 kc.; adjust No. 45 to max.
- (3) Repeat 350 kc. operation.

### Adjustment of Broadcast band.

- (1) Service osc. and dial indicator, 1,600 kc.; adjust Nos. 37, 21 and 7 to max.
  - (2) Oscillator and dial indicator, 570 kc.; adjust No. 44 to max.
  - (3) Repeat 1,600 kc. operation.
- Adjustment of Green Band.** Note: In adjusting green and red bands, connect a 200 mmf. condenser and 400-ohm resistor (in series) in the service oscillator "high" lead. (This combination is equivalent to a short-wave antenna.)

- (1) Oscillator and dial indicator, 5,500 kc.; adjust Nos. 35, 19 and 6 to max.

- (2) Oscillator and dial indicator, 1,900 kc.; adjust No. 43 to max.

- (3) Repeat 5,500 kc. adjustment.

### Adjustment of Red Band.

- (1) Oscillator and dial indicator to 17,000 kc.; adjust Nos. 34, 18 and 5 to max.
- (2) Oscillator and dial indicator to 6,000 kc.; adjust No. 42 to max.

- (3) Repeat 17,000 kc. adjustment.
- (Adjustment of condensers Nos. 43 and 42 is best made by the following "max-max." method.)

Tune the receiver and adjust condenser in either direction; then without changing it, tune the receiver through a maximum, noting reading of the output meter. Change condenser further in the same direction, retune receiver and note reading. If output drops with second adjustment, reverse direction of the adjustment. Continue this until no further improvement can be made when either the tuning control or the condenser are changed.

### D.C. Resistance (Measured with Wave-Change Switch in Corresponding Band Position)

Pos. of Coil	Dia. No.	Pri. Ohms	Sec. Ohms
P-Ant.	13	130	25
P-k.F.	24	36	25
P-Osc.	38	8.0	13.5
B-Ant.	12	22	4
B-R.F.	25	.5	4.5
B-Osc.	39	1.5	3
G-Ant.	11	3.2	1
G-R.F.	23	1.5	1
G-Osc.	40	.5	1
R-Ant.	10	1	.4
R-R.F.	22	2	.4
R-Osc.	41	.5	.4
I.F.1	53	8.5	8.5
I.F.2	62	3.5	3.5
I.F.3	75	11.5	11.5
Choke	110	350	
A.F.1 Trans. Output Trans.	84	3200	3800
Spkr. Field	112	265	
Voice Coil	114	312	.03

Operating voltages are as follows:

Tube Type	Plate Volts	S.-G. Volts	Cath. Volts
V1	245	100	2.5
V2	240	100	2.2
V3	200	—	—
V4	240	100	8.0
V5	255	100	8.0
V6	250	—	1.7
V7	—	—	—
V8	350	255	19.5
V9	350	255	19.5
V10	720	—	—

All measured from element to ground with 1,000 ohms-per-volt meter, and wave switch in broadcast position.

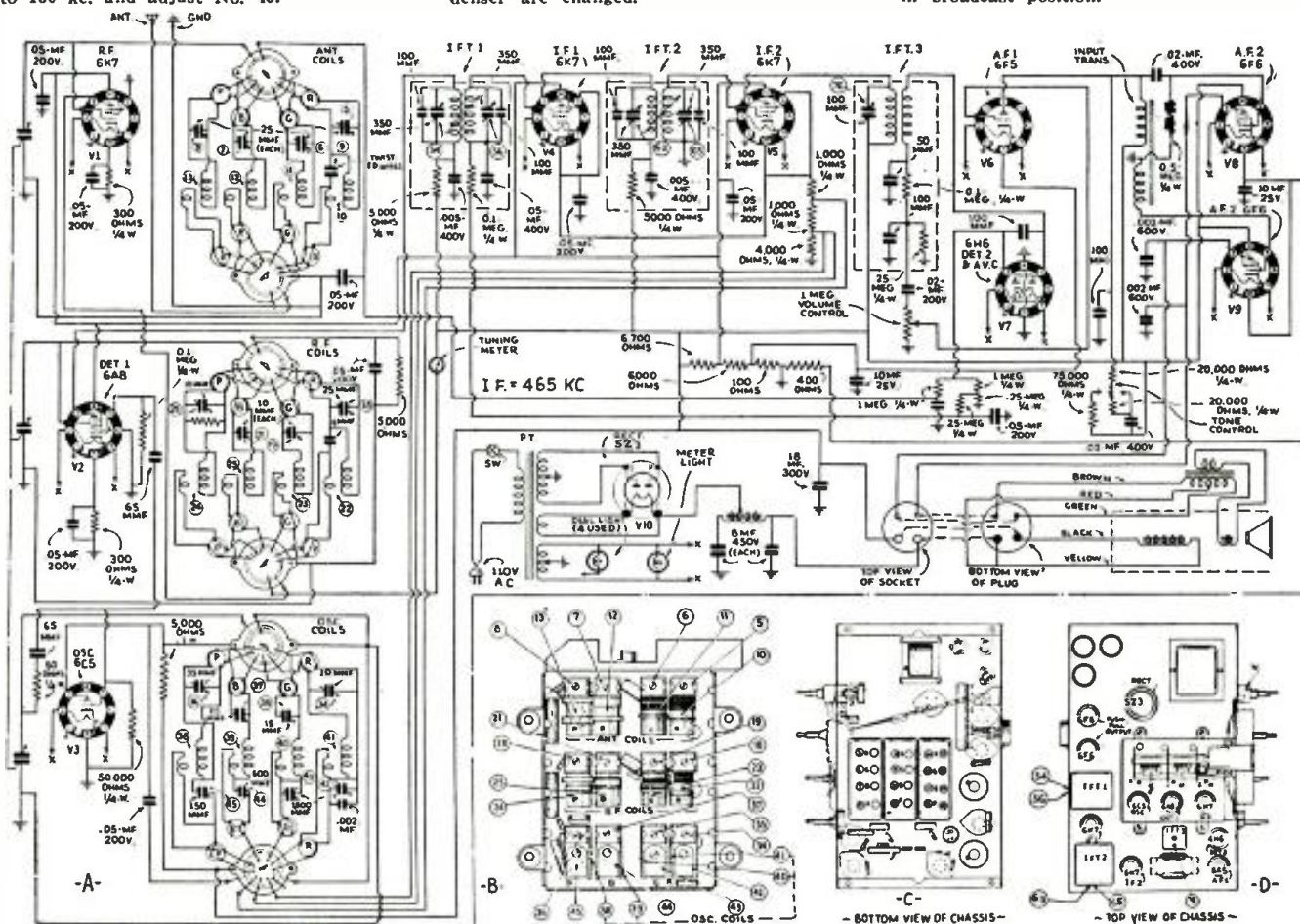

# ANALYSES of RADIO RECEIVER SYMPTOMS OPERATING NOTES

## WATCH FOR OUR NEXT SHORT-WAVE NUMBER

During the last year considerable improvement has been made in short- and all-wave technique and equipment.

The forthcoming, special SHORT-WAVE NUMBER of Radio-Craft will bring you right up-to-date on this important field. New sets, new circuits, and new accessories will be described. The constructor will find plenty to interest him. Service and other data will also be found in this issue.

## RADIOLA R-80

A CUSTOMER who owned a Radiola 80 complained of distortion when the volume was low, (OK when volume was high). A check of all tubes, voltages, and currents seemed to indicate that the set was in perfect shape. However, upon checking resistors *separately* we found that the 10,000-ohm "C" bias resistor between the cathode of the second-detector and ground measured about 15,000 ohms. Replacement with 10,000 ohms improved reception, but it was still not quite perfect. We found that 7,500 ohms worked still better (probably due to slight change in value of .11-meg. resistor between same cathode and plate supply). This may be seen in Fig. 3.

On another R80, the complaint was: reception only on a small part of the maximum end of the volume control; also, slight distortion. Screen-grid to ground measured 115 V. On checking resistors we found that a supposedly 14,300-ohm resistor between plate supply and screen-grid read only about 10,000 ohms. Replacement with a wound-wound 15,000 ohm, 5 W. resistor cleared the trouble perfectly. This is a frequent complaint on similar G. E. and Westinghouse sets.

B. J. STERNBERG

## G. E. MODEL K-80

NO reception could be obtained on any band, the audio system being OK. Abnormally high voltage was found on the control-grid of the 2A7, and low plate and screen-grid voltage on the same tube. All other voltages were a little low. A careful check revealed a short between detector coils L13 and L18 (see receiver wiring diagram). The coil unit was taken out and the short found to be at the beginning of the winding. A few inches of wire were unwound, cement was applied to the wire, and the turns replaced. After aligning, the set operated perfectly.

ROMAN LOPEZ

Quiriquire, Venezuela.

## HOWARD MODEL SG-B

THE complaint on this set is "oscillation," which becomes evident after a year or so of operation. The trouble

## THE PURPOSE OF THIS DEPARTMENT

It is conducted especially for the professional Service Man. In it will be found the most unusual troubles encountered in radio service work, written in a practical manner, by Service Men for you.

Have you, as a professional man, encountered any unusual or interesting Service Kinks that may help your fellow workers? If so, let us have them. They will be paid for, upon publication, at regular space rates.

## ALL-AMERICAN MOHAWK (LYRIC) RECEIVER

RECENTLY I had a very perplexing job of tracing down the cause of circuit oscillation in an All-American Mohawk receiver. This oscillation was very irregular—sometimes the set would operate perfectly for several hours at a time! I found that one of the dual bypass condensers was leaky. I replaced this and the set seemed to work perfectly. However, about three days later the owner said that the same trouble had started again. When I took the set back to the shop all voltages checked OK and everything seemed in perfect shape. The trouble was finally located by moving one of the terminals on the other bypass condenser. After replacing this condenser, the set worked better than it ever had before, so the owner said. See Fig. 1.

AMBROSE D. BAKER

## PHILCO MODEL 70

WHEN HOOKED up on the bench and turned on, the suppressor-grid of the 47 in a Philco 70 immediately turned red hot. We suspected the bias was faulty, but finally found that resistor 5-6 in the voltage divider (see Fig. 2) was defective, since it would short after a few seconds of heating. Replacement with a 10-W. unit of 240 to 300 ohms will cure the trouble for good. (Connection TFR goes to the power transformer.)

PACES RADIO SERVICE

Fig. 1. Condenser trouble in Lyric set.

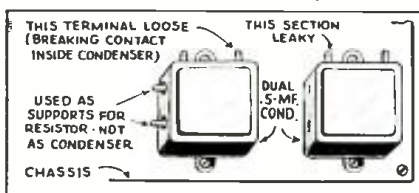

Fig. 2. No bias on 47 tube in Philco 70.

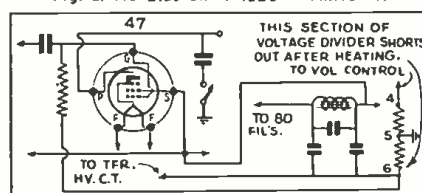
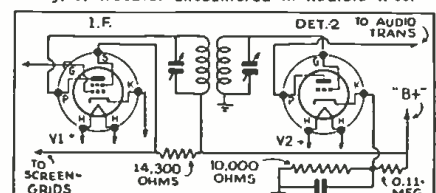

Fig. 3. Troubles encountered in Radiola R-80.



usually lies in the tuning condensers, the rotor wipers of which become dirty. The trouble can be temporarily cured by cleaning, but the only way to affect a permanent cure is to solder flexible wires from rotors to ground.

## GLORITONE MODEL 27

THIS set would play well for a time and then the volume would cut down. Sometimes the volume could be brought back to normal by switching a light on or off. All parts checked OK. The trouble was cured by soldering a flexible wire from the rotor of the tuning condenser to ground.

JAMES H. MILLS

## A "SOUND" EXPERIENCE

AN interesting experience occurred while working as a sound projectionist.

It was 1:30 P. M. and time to start the show. The arc light was burning; I started the machine, threw the picture on the screen—but no sound came forth! Hurriedly I looked around but could not see anything at fault. Occasionally, with the volume on the fader set quite high, a rasping sound would come, but no real music or talking. This was all traced to a poor contact on the grid prong of one of the sockets; the trouble arose, even though I had previously listened to a click from the stage speakers before starting time.

EINO A. KASARI

(Continued on page 375)

# EVERYTHING IN RADIO- *Under One Great Roof!*

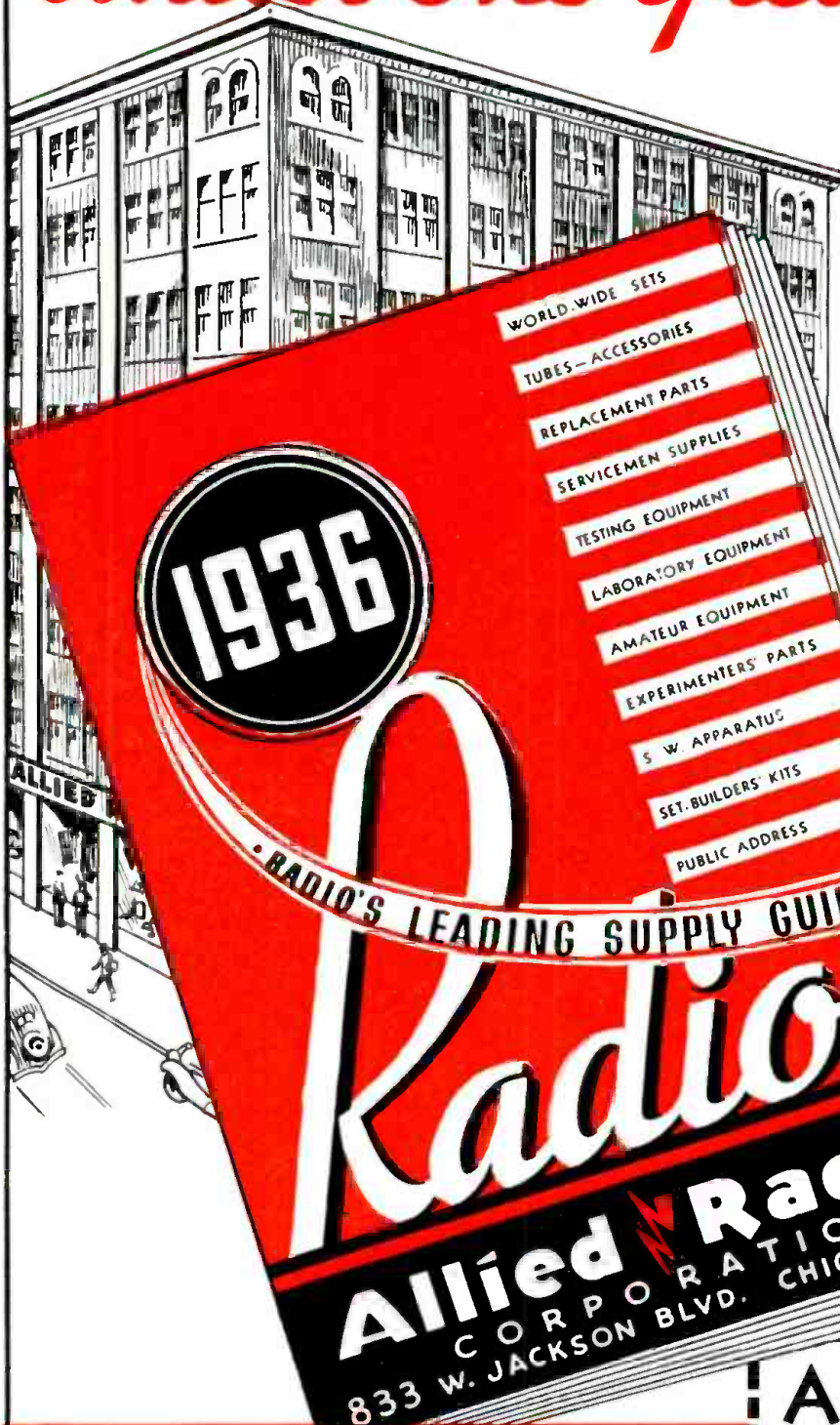

**A**LLIED has everything in Radio for everyone in Radio. We ship ALL our merchandise from one great center. Our vast choice stocks—our busy offices—our well-equipped laboratories—our super-efficient shipping department, are conveniently located in one great building. Any part . . . any size . . . any brand . . . is yours right when you want it, because, here, at ALLIED, we have assembled under one roof, the most choice and complete radio stock in the country. Climb on the ALLIED bandwagon! More than ever before everyone in Radio is turning to ALLIED. Why? Because ALLIED'S New super-values are unbeatable anywhere—because ALLIED'S 1936 prices have never before been matched in radio history! Little wonder that the radio world is buzzing with such remarks as: "You put money into your pockets when you buy from ALLIED!" Vast, top-quality stocks, streamlined service and lowest prices establish ALLIED as the world's Radio Headquarters.

## THE MOST COMPLETE RADIO CATALOG EVER PUBLISHED

ALLIED has published a new "streamlined" type of catalog for 1936. It is the most complete, the most compact, the smartest and the best-indexed catalog the radio world has ever seen. This catalog is as far ahead of the rest of the field as the airplane is ahead of the ox-cart. Everything in the Service, Dealer, Amateur and Set-Builders' fields is covered 100%. Metal tube, All-Wave, Short Wave, Battery and Auto sets; new P.A. Sound Equipment; new Service Test Equipment and tools; S.W. Receiving and Transmitting gear; thousands of parts—a vast array of sterling radio merchandise that challenges any competition.

# FREE

**Allied Radio**  
CORPORATION  
833 W. JACKSON BLVD.  
CHICAGO, ILLINOIS

**ALLIED RADIO**  
CORPORATION

833 W. JACKSON BLVD.  
Chicago, Illinois, Dept. D.

Send me your FREE 1936 CATALOG

Name .....

Address .....

City ..... State.....

Please Say That You Saw It in RADIO-CRAFT

# BUILD YOUR OWN ALL-WAVE ALL METAL TUBE

*Meissner*  
De Jong "8"

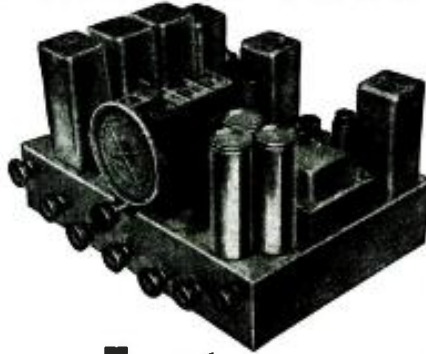

It's the latest "wrinkle" in radio receivers—with features not to be found in any other kit or receiver on the market!

Where else can you find such things as IRON-CORE I.F.'s—electrical band spread already mounted on the chassis base—a beautiful set of perfect coils (Ant.—R.F.—Oscillator) pre-mounted on the base and pre-balanced!

You don't need any instruments to build this set—just a screw driver, a pair of pliers and a soldering iron. All the balancing has been done for you in advance.

Ask your Parts Jobber for all the details—or send the Coupon to the factory for FREE literature!

## Features

- ★ Four Bands—giving continuous coverage from 540 kc.—25,000 kc. (15-550 meters.)
- ★ 8 All-Metal Tubes—with the Chassis especially engineered around them.
- ★ Iron-Core I.F. Transformers (Meissner Ferrocort)—the last word in super-selectivity and gain!
- ★ Meissner Coil Assembly (Ant. R.F. Oscillator)—pre-built, watched, mounted on the chassis and balanced.
- ★ De Jong Band Spread tuning unit—giving micromatic electrical band spread over entire tuning range.
- ★ Beat Frequency Oscillator for ease in tuning S-W phone and making Code signals audible.
- ★ Automatic Volume Control—Tone Control—and sufficient Output to cover the block.
- ★ Chassis Base already drilled for mounting parts.

### YOUR JOBBER HAS IT

MEISSNER MFG. CO.  
2815 W. 19th St.  
Chicago, Illinois

FREE details on the Meissner De Jong "8."

Name .....

Address .....

City .....

State .....

MAIL THIS COUPON

*Meissner*

2815 West 19th Street  
CHICAGO, ILLINOIS

## MIDWEST RADIO MART

offers for

IMMEDIATE DELIVERY

FREE *Meissner*  
↓ De Jong "8"

Write for the "Blue Book of Amateur Radio"

MIDWEST RADIO MART 520 S. State St., Chicago

Send me the "BLUE BOOK OF AMATEUR RADIO" and details of the DE JONG "8".

NAME .....

ADDRESS .....

listing all parts and complete Kit

## ORSMAs MEMBERS' FORUM

(Continued from page 324)

of the electricians' union or the A.F. of L. or form a separate union so that these cussed Young squirts can't cause any more unfavorable ideas in people's minds.

I know of several cases right here in Massena, of fellows that have gotten together enough money to get an analyzer, pick up a few technical terms, and imagine they are experts. The most that they accomplish is to "sling the bull" to people who don't know one end of a radio from the other. When the owner finds out that he was stung, a man who really knows his onions has got to either "prove" himself to some ignorant person or else do the job for fool's pay.

I want you to know, Mr. Gernsback, that I am very enthusiastic about this organization, and I want to see you get the drop on these fellows who have nothing but a smattering of radio and who don't know enough about electricity to wire up a burglar alarm in a back-house!

FRANZ E. WELLS,  
Massena, N.Y.

Any suggestions along the lines laid out by Mr. Wells will be appreciated. Undoubtedly, most well-informed Service Men have come up against the type of "expert" he mentions, and possibly some one will advance a workable plan to discriminate against these bunglers.

## CHEAP RESISTOR

RADIO-CRAFT, ORSMAs Department:

Save the No. 3615 bakelite boxes out of Philco radio sets, the ones which contain a condenser and resistor. The condenser, as a rule, gives out, but the resistor remains intact. This resistor is removed and may be used to make up any value, from 250 ohms, down. It is heavy enough, by doubling, to wire any voltage regulator. It is silk-covered, and very handy for making small meter shunts.

I would like to become a member of ORSMAs, and would appreciate it if you will send me membership requirements. I am now a member of R.M.A.

E. L. LAUDELL,  
Shelbyville, Ill.

The material has gone forward to Mr. Laudell. His suggestion regarding the wire for meter shunts is very interesting. Many Service Men have meters of various types which come in on old sets, and these meters can easily be converted to milliammeters. The meters were mostly on oldtime sets, and were used to indicate filament voltage or current. By removing the voltmeter series resistor, the meter may easily be shunted to read what you desire. The meters are invaluable for tube testers, condenser testers, low-reading ohmmeters, and the like.

(See the 3-part article, "Magic in Meters," in the November and December, 1931, and January, 1932 issues of *Radio-Craft*, and the various articles in subsequent issues, for detailed data on shunt and series meter resistors.—Editor)

## RADIO MONTH IN REVIEW

(Continued from page 327)

—present, one James Cabey, the Magistrate and a burley Patrolman.

The Patrolman: "Yes, your Honor, I saw him lugging this heavy burlap sack and I got suspicious and I went up to him and—"

The Magistrate: "Yes, well, what have you to say for yourself, Cabey?"

Cabey: "Well, your Honah; it was like this: I didn't have no money and I knew where there was some junk dealers and where there was some wire and I went up on the roof and—well, I cut the wire—"

Carefully, Cabey had coiled up the strands of aerial wire and stuffed them in his sack—as he snipped from roof to roof. He ended his labors while the repairmen were still tinkering and he was walking home with his sack when nabbed by the Patrolman.

Please Say That You Saw It in RADIO-CRAFT



## INTERNATIONAL RADIO REVIEW

(Continued from page 330)

lator which can be controlled separately, by means of an A.F. attenuator. The oscillator is a 3-hand arrangement covering the frequencies from 15 mcs. to 1,500 kc.

A few of the features are: electron coupling for stability; thorough shielding; calibrated attenuator (units and db.); control of output down to a fraction of a millivolt; 3-range variation of audio output frequency; variation of modulation depth; and provision for external modulation.

### ENGLISH IRON-CORE I.F. TRANSFORMER

A NEW TYPE of I.F. transformer was shown at the Radiolympia show in London, which took place recently, according to *The Broadcaster and Wireless Retailer*.

This transformer, which is tuned to 465 kc. for all-wave receivers, is wound with Litz wire and contains an R.F. iron core to give the greatest possible gain. In addition, the coils are tuned with air-dielectric condensers, which eliminates the nuisance of I.F. drift.

This transformer appears to contain practically every new development which has been made in I.F. coil design during the past year.

It may even be classed as a "semi-high-fidelity" type of transformer, as the coupling between primary and secondary can be varied to supply the desired degree of selectivity.

The makers of this transformer are to be complimented on their fine design work.

### NEW METAL CORES FOR R. F. COILS

(Continued from page 333)

characteristics. The material does not rust or corrode, nor alter its characteristics regardless of length of service.

The standard magicore is  $\frac{1}{2}$ -in. by  $\frac{3}{8}$ -in., with a  $\frac{1}{8}$ -in. center hole. Other dimensions can be met. Two cores are usually required for the standard I.F. or R.F. transformer or coil, separated by a gap determined by windings and other characteristics. Due to greatly augmented gain, coil dimensions may be reduced, facilitating a more compact chassis. The added gain is especially attractive to designers of aircraft, auto-radio and portable radio sets.

Although magicores are intended primarily for new set building or set production, they may be introduced in existing sets with startling results. *Even such acknowledged sloppy and crude practice as dropping these metallic cores into the coils of an old set will immediately reveal a marked gain in characteristics.* When coils are especially designed with a view to taking advantage of metallic cores, maximum gain can be realized.

The use of magicores in a transformer will more than double the gain, and will increase the Q of an 85 Q air-core coil to 140. A 95 Q air-core coil has been raised to 150 Q. The higher percentage gain in Q, the better the air-core coil. The gain is generally doubled over the air-core design. Selectivity is generally increased 2 1/4 times. The permeability is reported as at least 14 per cent better than iron cores heretofore available.

### A SIMPLE "RADIO" "LIE DETECTOR"

(Continued from page 335)

uation takes the form of a game similar to "Forfeits." The subject chooses some object in the room. He must watch while some person hunts for the object, but remains silent during the whole search. The operator keeps the searcher posted by calling "warm" for the slightest rise in the galvanometer reading, and "cold!" for the slightest fall. The object is usually easily located if the person hunting for it explores the room rapidly and thoroughly.

It is well to warn observers not to pop questions which might in any way compromise the subject of the demonstration.

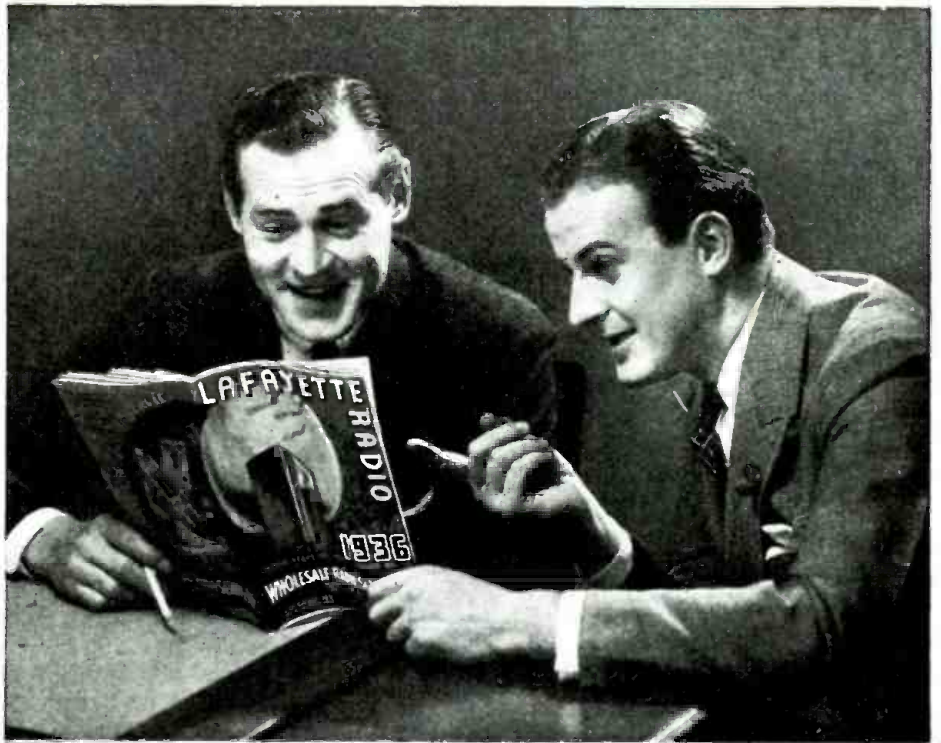

# This Catalog Can SAVE YOU MONEY... But It CAN DO Even MORE!



The "Largest Radio Catalog Ever Issued" can save you money, yes. You will find thousands of items—nationally known and nationally advertised merchandise—at money-saving prices! But you will also find other things equally important to you!

For example, this catalog has been called a Guide Book for the radio service man, buyer and "ham". Whatever you need in the field of radio is listed—whether it be a new, year-ahead 24-tube radio receiver with metal tubes or a 5c binding post. Tubes, kits, replacement parts, P.A. and "ham" equipment, receivers, accessories, tools—anything and everything.

It takes hours to actually read through this big new catalog—a radio show window more complete than any show could ever be. Spend some time with it—"shop" the Wholesale catalog! Keep it for handy reference—for comparison of prices and service. You will find it helpful in many ways!

*If You Haven't a Copy . . .*  
Send for it today! It's absolutely FREE, of course. Catalog number 59—196 pages—the latest, greatest radio catalog ever issued! If you already have a copy, perhaps this will serve as a reminder that it pays to "shop" the Wholesale Catalog. If you haven't received a copy, the coupon below will bring you one by return mail. Mail it TODAY.

Spend a moment, if you will, reading about the service that is our pride and joy—the fastest, most efficient service in the entire industry. Service made possible by three huge mail-order centers in New York, Chicago and Atlanta maintaining complete stocks of brand new, guaranteed merchandise.

WHOLESALE RADIO SERVICE CO., Inc.  
100 Sixth Avenue, Dept. RC 125  
New York, N. Y.  
Please rush FREE copy of your new 1936 Catalog No. 59.

Name.....  
Address.....  
Town..... State.....

# WHOLESALE RADIO SERVICE CO.

NEW YORK, N.Y.  
100 SIXTH AVE.

CHICAGO, ILL.  
901 W. JACKSON BLVD.

ATLANTA, GA.  
430 W. PEACHTREE ST. N.W.

Also at 542 E. Fordham Road, Bronx, N. Y., and 219 Central Ave., Newark, N. J.

Please Say That You Saw It in RADIO-CRAFT

# New! MUTER Interference Filters

## Man Made Interference!

This "Traffic Cop" of Radio absolutely eliminates the man made interference that comes in over the power line. With a MUTER Interference Filter on your set, you can enjoy clearer foreign and domestic programs without the accompaniment of your refrigerator, light switches, electric irons or other interfering noisy equipment.

### NO MORE POWER LINE NOISES

when you are tuning in your favorite program—just clear, unspoiled reception.

A Muter Interference Filter on your receiver itself is usually sufficient, but, when a particularly offensive electrical device is spoiling reception for yourself and your neighbors, attach a Muter Interference Filter direct to the offending equipment to silence it forever.

The Muter Filter has a capacity to silence interference from motors as large as 1/2 H.P., oil burners, flasher signs and similar high frequency disturbers.

Send for it today and learn what unalloyed pleasure you can get from an interference-free program.

### MAIL THIS COUPON!

THE MUTER COMPANY  
1255F South Michigan Avenue  
Chicago, Illinois

- Please RUSH me (postage paid) a Muter Interference Filter.
  - Send FREE General Catalog including list of Candomm original equipment resistors.
  - I am enclosing \$3.00
  - I will pay postman \$3.12
- SATISFACTION GUARANTEED

Name.....  
Address.....  
City..... State.....

#### RECOMMEND IT TO THAT OFFENDING NEIGHBOR

When some one's electrical equipment is "raising hob" with the radio reception of his neighbors, suggest installation of a Muter Interference Filter. He'll receive a vote of thanks from the whole neighborhood. If your jobber can't supply you, send the coupon.



THE MUTER COMPANY  
1255F So. Michigan Ave.  
CHICAGO, ILLINOIS  
U.S.A.

### WHAT PROMINENT RADIO MEN SAY ABOUT THE HOME LABORATORY

(Continued from page 328)

Goodyear, the home workshop of Alexander Graham Bell, all bear witness to this truism. I obtained the germ idea which led to the invention of the Audion in a small "hall bedroom," equipped simply with a Welsbach burner and a spark coil.

The home laboratory is unquestionably the nest where the brain of the inventor and the scientist is hatched and pinfeathered. There the youth of genius can best develop his own bent, hampered perhaps by lack of desired equipment, but by this very handicap driven to ingenuity and self-reliance. Yes, by all means, begin in the home laboratory, not forgetful of the equally necessary public reference library; and in time to come you may well aspire to help direct the perfectly equipped Research Laboratory of some gigantic Industry!

\*(Lee de Forest Labs.)

### THE LISTENING POST FOR ALL-WAVE DX-ERS

(Continued from page 332)

blocked by early-starting local stations.

Japan has also added some new broadcast stations, and from early reports this should be a great season for logging the Nipponese. California reports the Japs showing up as early as Sept. 1st, although we do not expect to hear them in the middle-west until late in November. Japanese stations are usually best at about 4 to 4:30 a.m. E.S.T.

There is little doubt that this will be the greatest season yet for South American stations, as the increase in power of some of the Buenos Aires stations has placed them almost in the super-power class; there are times in the early evenings when these powerful South American broadcasters block out the signals from stations in the U.S. operating on the same channel! Later, as darkness falls in the region of the U.S. station on that channel, the South American will generally be submerged behind the local signals, and only show its presence by a peanut whistle on the local. At times however, when the local station goes into a deep fade, the South American may come out on top for a brief period. Those receivers not equipped with A.V.C. will have better success at logging South Americans on these freak signal surges. The most powerful stations appearing at present are: LS2 Buenos Aires (1,190kc.), LR3 Buenos Aires (950kc.), LR6 Buenos Aires (870kc.), LR10 Buenos Aires (790 kc.), and YV1RC Caracas, Venezuela (960kc.).

European reception provides abundant thrills for those living on the Atlantic seaboard, and as far inland as the central-west at times. European stations will not become generally audible before late in November as far as the U.S. is concerned, although the stronger stations show up much earlier than this in Nova Scotia, and New Brunswick, Canada. Reports indicate that European reception is possible practically all summer in Newfoundland.

### JAPANESE SHORT-WAVE TRANSMITTERS

The following interesting, and valuable data on Japanese short-wave transmitters has been sent to us by our correspondent, Mr. A. Saito, of Kumamoto, Japan.—Editor

The International Telephone Co., Ltd. has a transmitting station at Nazaki, and a receiving station at Komuro, Japan. Short-wave programs of the Japanese Broadcasting Co., are transmitted, although the transmitters at Nazaki are built primarily for commercial telephone service. However, the Japan-to-America telephone service occurs daily between 4:00 p.m. and 1:00 a.m. E.S.T., and Japan-to-Europe, from 3:00 to 7:00 a.m. E.S.T. Therefore, the Japan-to-America transmitter is useless until 4:00 p.m. E.S.T., while the Japan-to-Europe transmitter is useless after 7:00 a.m. E.S.T. for its original purpose. Therefore, it is with these temporarily idle transmitters that the short-wave programs of the Japanese Broadcasting Co. take place.

### 7-TUBE SUPER KIT

Kit Includes: ANTENNA COIL; R.F. COIL; OSCILLATOR COIL; 1st I.F. COIL; 2nd I.F. COIL; 3-GANG TUNING CONDENSER. Price... \$1.95  
Schematic circuit diagram for A. C. and Auto Receiver furnished.



### T.R.F. KIT

ANTENNA COIL; 2 R.F. COIL; 3-GANG DEJUR TUNING CONDENSER. Price... \$1.25  
Write for our special circular radio parts and tubes.

Send enough money for parcel post or we ship by express collect.

ARROW SALES CORPORATION  
549 West Randolph St. Chicago, Illinois

### BRAND NEW

A. C. Amplifier  
Type 250

Sold in Kit Form



This latest Thor Amplifier employs five tubes—1-57, 2-50, 1-56 and 5Z3. Complete list of parts, including easily followed wiring diagram. Build this amplifier for phenomenal results.  
Complete kit, less tubes and speaker..... \$18.75

Rola High Fidelity Sneaker  
Including Output Transformer..... \$10.20

Special: FREE DIAGRAMS sent upon request for any of the THOR Amplifier or Tuner Kits.

MAIL ORDERS PROMPTLY FILLED



167 GREENWICH ST. NEW YORK, N. Y.

Please Say That You Saw It in RADIO-CRAFT

At Nazaki there are five separate 10 kw. transmitters, as shown in Table I, for point-to-point communication to the places indicated.

Table I

Transmitter No. 1, to Shinkio: JVU, 5,790 kc., JVO, 10,375 kc.; JVI, 13,560 kc.; and, JZF, 8,500 kc., shore-to-ship.

Transmitter No. 2, to P.I., Java, etc.: JVQ, 7,470 kc.; JVE, 15,660 kc.; JVB, 18,190 kc.; JZE, 13,020 kc., shore-to-ship.

Transmitter No. 3, to Taihoku: JVV, 5,730 kc.; JVL, 11,660 kc.; JVG, 14,910 kc., and JZG, 6,330 kc., shore-to-ship.

Transmitter No. 4, to Europe: JVP, 7,510 kc.; JVN, 10,660 kc.; JVH, 14,600 kc.; JVA, 18,910 kc.

Transmitter No. 5, to U.S.A.: JVT, 6,750 kc.; JVM, 10,740 kc.; JVF, 15,620 kc.; and JZD, 16,910 kc., shore-to-ship.

The Swiss Short-Wave Society, (USKA) Bern, Switzerland, has started a colonial short-wave program series over a number of Swiss short-wave transmitters, primarily for the benefit of Swiss countrymen residing abroad. These transmissions have been scheduled to take place the first Monday of every month, starting November 4th.

From 3:10 to 4:15 p.m. on these dates the following transmitters will operate:—HB9B, 21.07 meters, 14.236 mc., with a beam aerial to North America. HB9H, 42.83 meters, 7.005 mc., with an "omni"-directional aerial for Europe, Australia, North Africa, Central Africa. HB9J, 20.83 meters, 14.40 mc., directed on South and Central America.

In order to secure a world-wide coverage the whole program will be repeated between 6:00-7:00 p.m. E.S.T. over the following stations:—HBL, 31.27 meters, 9.595 mc., and HBP, 38.47 meters, 7.797 mc., also to be transmitted over the USKA stations HB9B, 21.07 meters, 14.236 mc., with a beam aerial to North America, and HB9AT, 20.99 meters, 14.290 mc., with a beam aerial to Netherland Indies, and Australia. Reports on these broadcasts are solicited and should be sent to the secretary of the Swiss Short-Wave Society (USKA), Bern, Switzerland!

The new short-wave transmitter in Buenos Aires which will soon start to transmit regular programs is owned by "El Mundo," a newspaper of that city.

LSX, commercial station of Buenos Aires (10.35) has also been broadcasting musical programs lately at irregular intervals between 7:30 and 8:00 p.m. E.S.T.

Germany plans to be the mightiest force of the nations in the short-wave field, as plans rapidly progress for a huge new short-wave broadcasting house, which will contain 44 small, and 8 large studios, and two new powerful short-wave transmitters to help "sell Germany to the World!"

YVQ, commercial station of Maracay, Venezuela (6.672) is putting on a fairly regular musical program period on Saturday nights between 8:30 and 10:00 p.m. E.S.T.

VK3ME, Melbourne, Australia (9.51), long one of the world's most popular broadcasters, is now on the air daily except Sundays from 5:00-7:00 a.m. E.S.T.

Jamaica, jewel of the West Indies is on the air! Each Saturday afternoon, from 5:00 to 5:30 p.m. E.S.T., VP5MK, owned by Cyril Lyons of Kingston, Jamaica, takes the air on a frequency of (7.02) to sell the attractions of Jamaica as a resort.

The Effie Morrissey, plowing her way to the Arctic seas on her annual voyage, is using the call letters W10XFP this year, and can be heard on a frequency of about 14.2 mc. at various times throughout the day.

For a real catch, watch for the frequent tests of that tiny station VK4GU, Brisbane, Australia, between 3:00 and 4:00 a.m. E.S.T. on Sunday mornings. Although this station only uses 16 W., on a frequency of 7.277 mc., it has already been logged in the United States!

VWY, Bombay, India (17.48) talks to London many mornings at 8:00 a.m. E.S.T.

OPM, the jungle station at Leopoldville, Congo, Africa (10.14) is being heard occasionally in the United States. Mr. J. Miller (Brooklyn, N.Y.) reports them between 3:00 and 3:40 p.m. E.S.T., while another reader reports them recently at 1:15 a.m. E.S.T.

VE9GW, has changed its call to CRCX, and carries the complete programs of the Canadian Broadcasting Commission between 6:30 and 11:30 p.m. E.S.T. The frequency is 6.09 mc.



# Actions Speak LOUDER Than Words!

The manufacturer of the famous 4-Pillar Radio Tubes is making and delivering *all* types of the new Metal Tubes as initial equipment for 1936 receivers and for jobbers' and dealers' replacement stock.

## SEEING IS BELIEVING...

but one can't see if METAL TUBES are even "lit", much less tell by simple examination if they are *perking* properly. This is where the good service men plus good test equipment come in. Each radio development makes good servicing more necessary. Raytheon's service deals give service men a wide range of instruments from which to choose. Write for full details. Also get the new Technical Tube Chart: 8th Edition (including all metal tubes). It's free!



**RAYTHEON**  
TRADE-MARK  
**4-PILLAR RADIO TUBES**

### RAYTHEON PRODUCTION CORPORATION

30 East 42nd Street, New York, N. Y. 445 Lake Shore Drive, Chicago, Illinois  
55 Chapel St., Newton, Massachusetts 555 Howard Street, San Francisco, Cal.

RAYTHEON PRODUCTION CORPORATION  
Dept. E-12, 30 East 42nd Street, New York, N. Y.

Please send 8th Edition Tube Chart

Name.....

Address.....

City.....

Please Say That You Saw It in RADIO-CRAFT

**CRYSTAL-VELOCITY RIBBON MIKE OPERATED  
7½ and 19 Watt Output 3-4 Stage AMPLIFIERS  
Available in FACTORY WIRED or SEMI-ASSEMBLED models**



• GAIN 3 Stage Model: 103 db. • GAIN OF 4 Stage Model: 129 db. • 3 Stage model can operate a crystal mike directly (without external pre-amplifiers). • 4 Stage models operate a velocity ribbon directly (without external pre-amplifier). • METAL COVER CASE furnished—equipped with ventilation louvres • SHIELDED and POLARIZED mike input receptacles. • PHONO-MIKE switch. • KIT MODELS furnished with fully explanatory blue prints—diagrams • COMPACT SIZE: 19½ x 6¼ x 6½ in. tall. • TUBES are readily accessible. • For 110 Volt AC 50-60 cycle. • FIELD for 1 to 3-2500 ohms (110 volt DC) dynamic speakers. • Completely HUM-FREE! • OUTPUT TRANSF. included—choice of 2-4-8-15-500 ohms.

• 7½ WATT OUTPUT MODELS •  
3 Stage; 103 db. 4 Stage; 129 db.  
KIT \$12.95 KIT \$16.50  
WIRED \$17.50 WIRED \$22.50  
TUBES: 1-57, 1-2A6, 2-2A5, 1-5Z3...\$2.14 TUBES: 1-57, 2-2A6, 2-2A5, 1-5Z3...\$2.72

• 19 WATT MODELS •  
FOUR STAGE—Gain 116 DB!  
KIT \$14.75 • Wired \$19.75  
TUBES: 2-57, 3-42, 1-5Z3...\$3.50

**FREE** SEND FOR OUR NEW 1936 WHOLESALE AMPLIFIER & RADIO No. 1035 SUPPLEMENT

**COAST-TO-COAST RADIO CORPORATION**  
565 SIXTH AVENUE, NEW YORK CITY, N. Y.

ings. When we can combine this economic situation with one in which we enjoy to work besides, we have perhaps the ideal situation.

\*(Rangertone, Inc.)

**WM. DUBILIER\***

Some of the most important discoveries made by Man were originated and nurtured in the home experimental laboratory. It is here that ideas can develop without the hindering pressure of sordid commercialism.

All branches of science have thus been cradled and radio is not an exception. Hertz, Marconi, Fleming, DeForest, Armstrong—to name but a few—found this instrumentality an indispensable aid. This is especially so since radio is rife with innumerable unknown variables. Mental theorems are thus limited if not faulty in scope and must be substantiated by the practical demonstrations of the experimental laboratory, as I have found from long experience.

The developments of many a home experimental laboratory have received rough and thankless treatment, only to be found of vast importance years later.

\*(Radio Patents Corp.)

**ALLEN B. DU MONT\***

Few people realize the immense value which the home experimental laboratory has been in giving us the many scientific achievements of the past half-century. If we analyze the major inventions which have been responsible for improving our mode of living we will find among these the Telegraph of Morse, the Telephone of Bell, the Phonograph and Electric Light of Edison, and Motion Picture Machine of Jenkins, the Aeroplane of the Wrights and the Vacuum Tube of DeForest.

At the time these inventions were made, in all cases, the particular inventor was working "on his own," and not at the instigation of any commercial organization. The reason for this is evident—the ideas seemed so impossible at the time that no one but the experimenter would spend time or money pursuing such ideas.

Radio-Craft's interest in furthering the home experimental laboratory is a worthy one which is bound to lead to further scientific advances.

\*(Allen B. Du Mont Labs.)



*Fear not*  
*fair damsel*  
**CENTRALAB**  
will save you

\*\$# that noisy control. This calls for heroic action, my good man. Get "CENTRALAB", the serviceman's friend if you would save the goil. Thousands of servicemen, everywhere, know the secret of smooth, noiseless controls. . . CENTRALAB.



For "better than ever before" results use CENTRALAB RADIOHMS for replacement... a small stock services practically all makes.

Buy Radio Service Man should be a member of the Institute of Radio Service Men

**Centralab**  
MILWAUKEE WIS.  
RADIOHMS SUPPRESSORS  
FIXED RESISTORS

**RADIOS..SAVE UP TO 50%**

DEAL DIRECT: Factory Price. Many models to select from AC-DC. All-wave, Farm, Car and new metal Tube Models. Your name and address on postcard brings you NEW 24-page 1936 Bargain Catalog in color FREE. Get details of 30-DAY TRIAL plan and Rent-User proposition. Goldenstone Radio Co., Dept. 216 8780 Grand River, Detroit, Mich.

30 DAY TRIAL \$6.98 Free Catalog

**WHAT PROMINENT RADIO MEN SAY ABOUT THE HOME LABORATORY**

(Continued from page 328)

**AUTHOR H. LYNCH\***

It seems to me that there has never been a better opportunity for the serious experimenter to find interest in scientific research than exists today.

With all of the large broadcasting companies preparing to broadcast experimental programs which will include the use of the ultra-high frequencies for television and facsimile, in addition to regular sound broadcasting, it is worth noting that many leaders in the professions are among the most active radio experimenters we have.

In radio, as we find it today, there is a fertile field for the investigator, whether he be young or old.

\*(Pres., Arthur H. Lynch, Inc.)

**JOHN V. L. HOGAN\***

It is my view that the home experimental laboratory is an important factor in the scientific progress of our nation. Young men who develop sufficient interest in applied technology to carry their school instruction into their homes, and there to establish and maintain facilities for experimental extension of their scientific ideas, are apt to become genuine contributors to scientific advancement. The final results of such home experimental work should not be appraised only on the basis of practical accomplishments completed, but as an important and valuable contribution to the development of research habits and analytic thought, all of which has repeatedly proved to be a sound basis for progress in engineering fields.

\*(Radio Pictures, Inc., Scientific Broadcasting Service)

**R. H. RANGER\***

I am reminded of what the late General George Owen Squier said in this connection. "Did the laboratories of the telegraph companies invent the telephone? They did not. Did the laboratories of the telephone company invent the microphone? They did not. Then loading? Then the vacuum tube? Then the pay station? Also automatic operation? Then carrier current?"—which was the General's contribution, of course.

Just last week I was talking with Mr. B. F. Miessner, who is making such a real contribution to electric music from his laboratory out here in Millburn (N.J.), and he puts it on the basis of the insistence of the demand on the individual inventor to get something that he can really sell, rather than any particular brain power that brinks about the strikingly new developments that come from such workers. And of course the large corporation laboratories make their biggest contributions in the way of continuous improvements, which again is a matter of the insistence of increasing the earn-



Allen B. Du Mont in his private tube lab.

**AN EXPERIMENTER'S I-TUBE DOUBLE-REGENERATIVE SUPERHET.**

(Continued from page 337)

C2; this eliminates the need for a padding condenser, and its subsequent meticulous alignment. Center-tapped resistor R3 will be required only in the event that the "A" supply is derived from a filament transformer.

**LIST OF PARTS**

- One Acratest kit of 456 kc. superhet. shielded coils, L1 (with tickler), L2-L.F.T.1;
- One Acratest 50,000-ohm tapered volume control, R1, with switch Sw.1;
- One Acratest 10,000 ohm tapered volume control, R2;
- One Acratest 2-gang 365 mmf. variable condenser, with 456 kc. tracking section, C1, C2;
- One Acratest 0.1-mf. paper condenser, C5;
- One Acratest 100 mmf. paper condenser, C6;
- One Acratest .001-mf. paper condenser, C7;
- One Acratest 500 mmf. paper condenser, C8;
- Two Acratest 250 mmf. mica condensers, C9, C10;
- One Acratest 2 mf. paper condenser, C11;
- One Acratest 25 mhy. R.F. choke. R.F.C.;
- One National Union type 6F7 tube, V1;
- One Acratest 7-prong socket, for V1;

Please Say That You Saw It in RADIO-CRAFT

# TECHNICIANS' DATA SERVICE

JOSEPH CALCATERRA DIRECTOR

A special arrangement between RADIO-CRAFT magazine and the publishers of this literature, which permits bulk mailings to interested RADIO-CRAFT readers, eliminates the trouble and expense of writing to each individual organization represented in this department.

2. HAMMARLUND 1936 CATALOG. Contains 12 pages of specifications, illustrations and prices on the new line of Hammarlund variable, mid-gel, band-spread and adjustable condensers; trimming and padding condensers; R.F. and I.F. transformers, coils and coil forms; sockets, shields, chokes and miscellaneous parts for ultra-short-wave, short-wave and broadcast operation.

3. HOW TO GET A HAMMARLUND 1936 SHORT-WAVE MANUAL. A circular containing a list of contents and description of the new 16-page Hammarlund Short-Wave Manual, which contains construction details, wiring diagrams, and list of parts of 12 of the most popular short-wave receivers of the year.

4. THE "COMET PRO" SHORT-WAVE SUPERHETERODYNES. Describes the outstanding features of the standard and crystal-type Hammarlund "Comet Pro" short-wave superheterodynes designed to meet the exacting demands of professional operators and advanced amateurs for a 15 to 250 meter code and phone receiver, but which can be adapted by anyone for laboratory, newspaper, police, airport and steamship use.

5. ELECTRAD 1936 VOLUME CONTROL AND RESISTOR CATALOG. Contains 12 pages of data on Electrad standard and replacement volume controls. Truvolt adjustable resistors, vitreous wire-wound fixed and adjustable resistors and voltage dividers, precision wire-wound non inductive resistors, center-tapped filament resistors, high-quality attenuators, power (50- and 150-watt) rheostats and other Electrad resistor specialties.

25. LYNCH NOISE-REDUCING ANTENNA SYSTEMS. Complete descriptions and instructions issued by Arthur H. Lynch, Inc., for making all kinds of antennas for broadcast and short-wave reception, with a special supplement covering Ham Antenna Design for transmitting as well as receiving all the amateur bands, including the ultra-high frequencies.

26. LYNCH AUTO RADIO ANTENNAS, FILTERS AND NOISE SUPPRESSORS. This folder describes a complete line of Lynch antennas, filters and ignition noise suppressors designed for auto radio installations. The antenna system is of the under-the-car type for easy installation. It includes data on Hi-Gain matched-impedance transmission lines which make the under-car antenna highly desirable for use with the new "Turret-top" cars.

28. LYNCH SUPER-FILTASTATS FOR AUTO RADIO INSTALLATIONS. Describes and illustrates, with instructions for using, the new Lynch Super-Filtastats which do away with the need for suppressors in auto-radio installations, giving better performance in operation for both the car and radio set.

57. RIBBON MICROPHONES AND HOW TO USE THEM. Describes the principles and operating characteristics of the Amperite velocity microphones. Also gives a diagram of an excellent humless A.C. and battery-operated preamplifier.

62. SPRAYBERRY VOLTAGE TABLES. A folder and sample pages giving details of a new 300-page book, containing 1,500 "Voltage Tables" covering receivers manufactured from 1927 to date, published by Frank L. Sprayberry to simplify radio servicing.

64. SUPREME No. 385 AUTOMATIC TESTER. A technical bulletin giving details, circuits and features covering this new Supreme development designed to simplify radio servicing. In addition to the popular features of Supreme analyzers and tube testers it contains many direct-reading features which eliminate guesswork or necessity of referring to charts or tables.

67. PRACTICAL MECHANICS OF RADIO SERVICE. Information, including cost, features and outline of lessons of the Frank L. Sprayberry course in Radio Servicing, and list of Sprayberry Data Sheets for modernizing old radio equipment.

72. HALLICRAFTERS' SKYRIDER SHORT-WAVE RECEIVERS. Description of the Sky rider tuned R.F. and Super Sky rider superheterodyne short-wave

Radio-Craft Technicians' Data Service  
99 Hudson Street.

New York City, N.Y. RC-1235

Please send to me, without charge or obligation, the catalog, booklets, etc. the numbers of which I have circled below.

2	3	4	5	25	26	28
57	62	64	67	72	74	75
76	77					

My radio connection is checked below:

- Service Man operating own business.
- Service Man for manufacturer.
- Service Man for jobber.
- Service Man for dealer.
- Service Man for servicing company.
- Dealer.
- Jobber.
- Experimenter.
- Professional Set Builder.
- Amateur Set Builder.
- Short Wave Work.
- Licensed Amateur.
- Station Operator.
- Radio Engineer.
- Laboratory Technician.
- Public Address Worker.
- Manufacturer's Executive.
- Student.
- .....

I am a:

- Subscriber  Newsstand reader

I buy approximately.....of radio material a month. (Please answer without exaggeration or not at all.)

Name .....

Address .....

City..... State.....

(Please print name and address)

Avoid delay. The catalogs and booklets listed are now in stock and will be sent promptly as long as the supply lasts.

receivers designed and built by Hallicrafters, Inc. Features: range of 13 to 200 meters (with broadcast or 10-meter band optional), automatic wave-change switch, continuous band-spread, built-in monitor, speaker and power supply (or batteries), high-fidelity audio, and other refinements.

74. SPRAGUE 1936 ELECTROLYTIC AND PAPER CONDENSER CATALOG. Gives specifications, with list and net prices on a complete line of wet and dry electrolytic, and paper condensers made by the Sprague Products Co. for radio Service Men, set builders, experimenters and engineers. Information on the Sprague Capacity Indicator, for making capacity tests on condensers and in servicing receivers, is included.

75. SPRAGUE TEL-U-HOW CONDENSER GUIDE. A valuable chart, compiled by the Sprague Products Co. which tells the proper types, capacity values and voltages of condensers required in the various circuits of radio receivers and amplifiers, and how to locate radio troubles due to defective condensers. Includes data on condenser calculations.

76. FACTS YOU SHOULD KNOW ABOUT CONDENSERS. A folder, prepared by the Sprague Products Co., which explains the importance of various characteristics of condensers, such as power-factor, leakage, capacity and voltage in determining the efficiency or suitability of a given condenser to provide maximum filtering and safety in operation.

77. SUPREME 391 P.A. ANALYZER. This booklet describes the features and use of the new Supreme 391 P.A. Analyzer, designed to equip the radio Service Men to cash in on the constantly growing opportunities for service in the sound equipment and public address systems used in movie theatres, schools, churches, auditoriums, etc.

## TRIUMPH BUILDS INSTRUMENTS

not \*puzzles



MODEL 420 TRIPLE LOAD R. M. A. TUBE TESTER. Hot tube leakage and shorts tests. All elements individually selected. Solid walnut duo-purpose cabinet. DEALERS' NET PRICE \$29.94.



MODEL 110 SIGNAL GENERATOR. Simple to operate. No charts. Just dial from 100 K. C. to 30 M. C. Genuine T Pad attenuation to zero. Separate audio. Spotted frequencies. DEALERS' NET PRICE \$29.94.



MODEL 400 NEONIZED DYNAMIC MUTUAL CONDUCTANCE TUBE TESTER. Unique Emission and leakage tests with tube hot. Tests metal and glass tubes. Counter or Portable. DEALERS' NET PRICE \$34.95.

MODEL 300 MULTIRANGE METER. Reads audio output. A.C. and D.C. volts to 1000. D. C. Mils. Resistance 1/2 ohm to 10 megs. 11 ranges—one switch. Separate Red and Black scales. DEALERS' NET PRICE \$19.95.



\*TRIUMPH Instruments are SIMPLE, DIRECT and EASY to USE. Each for a separate and distinct purpose. No misleading claims.



TRIUMPH MANUFACTURING COMPANY  
4019 W. Lake St. Chicago, Illinois

Please Say That You Saw It in RADIO-CRAFT



## Are Other SERVICEMEN Getting Ahead FASTER THAN YOU ARE?

Have your earnings shown a substantial increase in keeping with improved general conditions?

Can you handle all types of work (including Oscillograph testing) in the quickest, most efficient modern manner?

If you cannot answer such questions to your own satisfaction THEN you owe it to your future to mail the enclosed coupon TODAY. I have helped hundreds of servicemen. I feel sure I can help you. The cost is surprisingly low—the training intensely practical. INVESTIGATE!

**LET ME HELP  
YOU BUILD A  
REAL SERVICE  
BUSINESS**



**F. L. SPRAYBERRY**, 2548 University Pl., N. W., Washington, D. C.

Without obligation, send your book "PUTTING PROFITS AND EFFICIENCY INTO SERVICING."

Name.....

Street.....

City.....RC 12/35

**SPRAYBERRY'S PRACTICAL  
MECHANICS OF RADIO SERVICE**

## LIBERAL ALLOWANCE MADE ON YOUR OBSOLETE INSTRUMENTS

Trade in your obsolete meter and purchase the modern serviceman's Universal Tester



**Volts A.C.-D.C.**  
5-25-100-250-1000  
1000 ohms per volt

**Milliamperes D.C.**  
1-10-100-1000

**Capacity**  
.001-10 Mfd.  
Paper or electrolytic  
condensers.

**Inductance**  
1-10,000 Henrys

**D.C. Resistance**  
.5-5,000,000 ohms.

Send full description of obsolete instrument you wish to trade in, and 6c in stamps for Bulletin 611-PB describing the Shallcross Universal Tester.

Shallcross Mfg. Company, Collingdale, Pa.

## TELEVISION IN THE THEATRE

(Continued from page 333)

sequence are still found in the case of rapidly moving objects, and in the stroboscopic backward-turning of the wheels of pictured vehicles.

Television pictures may be projected in two sets of 30 pictures each, the two sets being projected in 1 second. "Interlaced" scanning may be used, and under these conditions a substantially flickerless picture is obtained. Despite the projection of 60 half-detail pictures per second by this method (equivalent closely to 30 full-detail pictures per second), it is possible to use ordinary 24-frame-per-second motion picture film for the television subject without undue difficulty by the use of technical expedients which cannot be here described.

(9) Viewing Distance. Taking an optimum viewing distance of 4.5 or 5 times the picture diagonal, theatre pictures may be most conveniently viewed from 45 to 135 ft. from the screen.

Home television pictures will be viewed from about 4 to 11 ft. from the screen.

This is a ratio of viewing distances of about 11-to-1 in the two cases.

(10) Audience Size. Long experience has demonstrated that the comfortable size for theatre audiences ranges from 500 to 5,000 persons, with perhaps some doubt at one extreme or the other.

The corresponding home audience may be expected to include from 3 to 15 persons, a ratio in favor of the theatre of about 200-to-1.

It must not be inferred, however, that the economic ratio for the two fields is anything like as high as this—indeed it has not yet been determined just what will be the cost per person per hour of entertainment for home television-telephone broadcasting.

(11) Synchronism of Picture With Sound. In the theatre, the picture and sound are correctly associated within 1/24-second, assuming proper editing and threading.

In the case of home television-telephone programs, the synchronism is even closer (though this is not noticeable as an advantage), and is entirely correct and automatic. Some rather romantic writers on the subject have dilated upon the "marvel" of the synchronism of picture and sound in such programs. As a matter of fact, considering the fundamentals of the processes employed, it would be even more marvelous if synchronism were not attained for television-telephone broadcasting reception!

It is not practicable at this time, before mass production of television equipment has been initiated, to give a reliable comparison of the cost of theatre and home equipment. In a general way it may be said that theatre equipment costs in the thousands of dollars and home equipment about the same number of hundreds of dollars, thus giving a cost ratio of perhaps 10-to-1. Here again some caution must be used in interpreting such figures since there are numerous other economic factors involved in a valid comparison.

While it is not feasible within the limits of this presentation to give even an outline of the various methods employed in modern television, some numerical data concerned with picture detail may be included as of present interest. These consist first of a personal opinion, in motion picture terminology, of the value and characteristics of television pictures having various numbers of dot-elements composing them. The figures are understood to be merely generally descriptive, but it is believed they are instructive in judging the "motion-picture value" of various television systems; hence, they are reproduced in Table I.

Table I

Elements in Picture	"Motion Picture Value"
10,000	A fair close-up of one person (head and shoulders).
20,000	Two persons in a moderately good close-up (though without fine detail).
40,000	Fair medium shots.
80,000	Good medium shots and fair, long-range shots.
160,000	Excellent close-ups of several persons, good medium shots, and acceptable long-range shots (except for unusual "pageant" subjects and the like).

Taking the last-mentioned type of television picture, and assuming flickerless transmission, it is found that the required "side-bands" produced by the picture modulation of the ultra-

short-wave carrier have a width of the order of 1.5 megas. (or about 150 times the frequency band required for high-fidelity or 10,000-cycle sound reproduction)!

## COMPARISON OF PRODUCTION TECHNIQUE

*Contacts and cooperative possibilities between motion pictures and television.* By this time the reader must see that there can be a close connection between motion pictures and television, if such is desired.

A person viewing a small picture in motion with synchronized sound might find some difficulty in knowing whether he was viewing a sound motion picture projected from film or a television-telephone broadcasting reception. He might be even more puzzled if the subject matter were, say, a newsreel used to control the television-telephone transmitter, an entirely feasible procedure. Obviously the technique of producing a television-telephone broadcast program will closely resemble that of producing a sound motion picture. Methods of costuming, make-up, script construction, "camera" technique, sound pick-up, set construction and illumination, and the like may well be similar in the two fields, though probably not with the same degree of elaborateness in the case of television. There is one respect in which they will necessarily differ if an original performance (rather than a film record) is broadcast. This is a limitation of television-telephone broadcasting; namely, the possibility of only one "take," viz., the one that is broadcast. In motion picture production, any reasonable number of takes may be made; not so in broadcasting, where the radio wave irrevocably carries the selected performance to all homes.

As has been mentioned above, sound motion films may be excellent subject matter for programs from some stations, and may even afford one means of syndicating programs in somewhat the same way electrical transcriptions (phonograph disk records of programs) now used. It is not believed, however, that television-telephone syndication will be fully satisfactory unless there are also actual interconnecting wire or radio networks between the outlet stations, since there will be many occasions (for example, a speech by the President, a political Convention, an evening prize fight, and the like) when the public can hardly be completely satisfied by any radio performance which does not take place at the same time as the actual event. Indeed it must be admitted that this is one of the outstanding capabilities of radio broadcasting which it would be unwise to discard.

Many persons are convinced that television broadcasting will whet the appetite of the "lookers," and, so far from diminishing the theatre audience, will build it up by arousing interest among children and adults alike in the probably more elaborate and highly developed offerings of the theatre. It is also clear that the theatre can, to a considerable extent, utilize radio advertising by television-telephony; for example, by the sponsored transmission of trailers of one sort or another. Radio will then offer the theatre a remarkably effective method of submitting its "sample line" to the public.

## COMPARATIVE COMMERCIAL CONSIDERATIONS

*Possible effect upon the theatre of the widespread acceptance of television-telephone broadcasting.* We are inclined to be definitely optimistic as to this. The argument that television broadcasting may keep people out of the theatre does not appear to have much weight. Consider, for example, the following controlling principles:

(1) Intrinsically, the home is certainly not so good a showplace as the theatre. First—it is more difficult to suppress natural and man-made noises in the home; second—here manners tend to be more "free and easy" than is desirable for showmanlike presentations; third—the problem of setting up the theatre in the home is far from simple when furniture must be moved to afford a good view of the screen and the home folks and guests located in the corresponding convenient viewing positions; and, fourth—home lighting is rarely as controllable or suitable for picture presentation as is the case in the theatre. Indeed, the customary surroundings of the home are not especially favorable for the creation of a world of illusion, which has always been the successful function

Please Say That You Saw It in RADIO-CRAFT

of the theatre. It is not maintained that there will not be value and interest to the home presentation—quite the contrary. It is stressed, however, that the home has certain disadvantages of long standing for program presentation which cannot be disregarded.

(2) Conversely, the theatre has a number of definite and inherent advantages as a showplace. It arouses the interest of the audience by heavy theatre advertising in the press, by the play-up of the "fun magazines," and by other exploitation methods known to skilful managers, thus creating in the prospective audience the proper mood of pleasurable anticipation. The marquee and lobby of the theatre, ablaze with light and motion, and with attractive photographs of selected scenes from the picture displayed within, further attract the audience. Within the theatre, suave but real discipline is maintained by the ushers—a task calculated to daunt the bravest in the home. Furthermore, the price of admission, exacted at the box-office just before entry, is a powerful deterrent to lack of interest on the part of the audience. It takes a poor picture indeed to force the audience to cheat itself by inattention.

The program in the theatre generally is a well-planned arrangement of elements which fit together and which take as long as may reasonably be required to get the desired effect. In broadcasting, because of certain administrative problems, the successive elements of the evening program are coordinated only with the utmost difficulty, if at all, and necessarily run in 15- or 30-minute slices—a not always convenient or artistic time. At the present time, with the occasional obnoxious exception of excessively prolonged or unduly fulsome blurbs relative to approaching attractions, the theatre screen is practically free from advertising, whereas advertising and the sponsored program are at present the commercial bases of the maintenance of broadcasting. The elaborate perfection of some feature pictures will be duplicable only rarely within the necessary economic limits of broadcasting. To the preceding factors may be added the air-conditioning of many theatres and the attempts at comfortable theatre seating, lighting, and the like. All in all, theatres may be expected to be attractive places of the public regardless of other entertainment media.

(3) If we consider some deep-seated characteristics of human beings, it becomes further evident that the theatre has certain ways of holding its own alongside a successfully developed television-telephone broadcasting set-up. People are interested in change. If they are in the home a good deal—and most of them are—they naturally will seek some of their entertainment and diversion elsewhere. The remarkable vogue of the automobile in which many people wander rather aimlessly from one place to another largely for the sake of motion is a case in point. People are also gregarious and somehow seem to have their emotional responses enhanced by crowd enthusiasm.

It seems most likely, therefore, that the theatre and television-telephone broadcasting will each be successful fields in their own domain, and that the theatre need not be unduly apprehensive over the advent of television.

### IMPROVED BOOSTER FOR S.-W. AND ALL-WAVE SETS

(Continued from page 339)

The "B" voltage requirements are very low and can be supplied by almost any set, without overtaxing it.

The preamplifier can be used on any set, from a 2-tube homemade job to the latest 25-tube "super-masterpiece," and on any of these sets it will give a noticeable improvement.

The interior layout is shown below

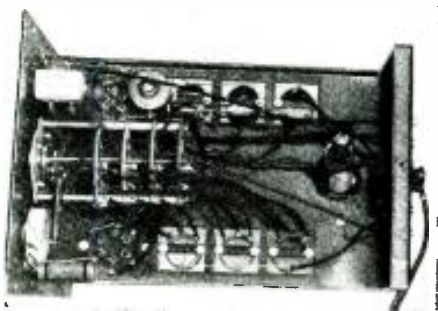

## New-Type ELECTRAD CARBON VOLUME CONTROL

Smooth • Quiet • Long-lived

"IT'S the TOP in replacement volume controls" is the enthusiastic endorsement service men are giving this new Electrad development.

A radically improved design and mechanism in which the carbon resistance element is fused to the flat outer rim of a sturdy Bakelite ring, over which a special-alloy floating contact shoe gently glides in a straight line. This results in smooth, quiet, long-lived operation never before attained, and which actually improves with use.

The molded Bakelite case, when mounted, extends only 1/2 inch back-panel. New-type power-switch (approved by underwriters) may be instantly attached or removed by a single screw. Long, easy-to-cut aluminum shaft saves time and trouble. All standard and special values.



Illustrating the complete working mechanism of the control, showing traveling position of contact shoe on the resistance element.

**RESISTOR SPECIALISTS**  
Featuring—Quiet Carbon Volume Controls, Vitreous Resistors, Truvalt Resistors and Power Rheostats.



Write Dept. RC-12 for New Catalog

### New 100-Page VOLUME CONTROL GUIDE

FREE, if you send us the flap (part showing specification and resistance) torn from any new-type Electrad Carbon Volume Control carton, together with your business letterhead or card.



6 1/4" x 9 1/4"  
Address: Dept. RC-12

## BUILD THIS 10-TUBE PROFESSIONAL SUPERHET AND SAVE OVER 50%



### 9 to 175 Meters "RADIO-SILVER" HIGH-FREQUENCY SUPERHETERODYNE

This new "RADIO" SILVER Superhet—designed by McMurdo Silver, Frank Jones and fifteen leading manufacturers—brings you

- Two tuned r. f. stages on all four bands.
- Ten Raytheon tubes.
- Four low-C tuning bands, 1700 to 33,000 kc. (9 to 175 meters).
- Ample Crowe band spread tuning anywhere in its range.
- Bliley Crystal single signal filter that doesn't cut volume.
- All A. C. operated—one unit—no hum.
- 8-inch Jensen concert speaker—and phone jack.
- Polished chromium welded chassis.
- Air tuned Polyiron i. f. transformers.
- Separate r. f. coils positively switched for each band—all Hammarlund air trimmed.
- Sensitivity 1 microvolt and better.
- Selectivity just what you want—variable 50 cycle to 10 kc.
- Amplified automatic volume control.
- No inherent circuit or tube noise—lets you copy signals now lost in noises.
- Wired with made-up color coded cable—requires no circuit tracing, or even a diagram.

HERE'S the latest in high-frequency superhets—one that you can assemble, test and align in one evening at home. It's fun to build . . . you'll save money . . . and boy, will you get a kick out of its amazing performance!

### START FOR AS LITTLE AS \$7.30 BUY THE PARTS AS YOU BUILD!

The 32-page "HOW TO BUILD IT" Book (sent for 10c, stamps or coin) tells the whole story of 1935's outstanding communication receiver. You can build and align it in a few hours . . . or you can buy its standard parts from your local jobber as you build, if you haven't already got many of them. Now is the time to get ready for the new DX season.

#### SPONSORED BY

Bliley Piezo Electric Co., Crowe Name Plate and Mfg. Co., Hammarlund Mfg. Co., Chicago Transformer Corp., Yaxley Div. of P. H. Malloy Co., Jensen Radio Mfg. Co., Sprague Products Co., Continental Carbon Co., Ohmite Mfg. Co., Readrite Meter Works, Raytheon Production Corp., Alladin Radio Industries, Inc., Steel Box & Display Co., Filtermatic Mfg. Co., McMurdo Silver Corp.

SEND 10c FOR 32-PAGE BOOK "HOW TO BUILD IT"

R-S MERCHANDISING COMMITTEE  
1709 Roscoe Street Chicago, Ill., U. S. A.

Please Say That You Saw It in RADIO-CRAFT

# NEW! IMPROVED!

## Dynatest

### BY OXFORD



Every amateur and professional radio-crafter should have this time saving, labor saving speaker on the testing table. Matches any power tube circuit with two special universal transformers. Matches all output transformers. Dynatest enables you to test any radio without its speaker. Multiple field tapped at 650, 1000, 1500, 2000, 2500, 3000, 5000, and 11,000 ohms, with special taps at 300 and 2500 ohms. Equipped with new style binding posts for easier circuit selection.

Write for Free Dynatest Service Instructions and Complete Oxford Replacement Speaker catalog.

**PORTABLE MODEL . . . Net \$13.50**

Laboratory Model \$12.90  
Panel only, completely wired \$11.75  
(size of panel 12"x12"x4 1/2" deep)

## OXFORD TARTAK RADIO CORP.

350 W. Huron St. Dept. C-125 Chicago, Ill.

## AT THE NEW YORK RADIO SHOW—

(Continued from page 336)

The October, 1935 issue of *Radio-Craft*—the METAL TUBE NUMBER—illustrated the interior appearance of the metal tube when X-rayed; an actual X-ray setup at the Show in the same manner permitted personal examination of several metal tubes.

The equipment used in the "delayed speech" system described on page 72 of the August, 1935 issue of *Radio-Craft* was demonstrated at the Show by Bell Telephone Laboratories.

The "radio knife" mentioned in past issues of *Radio-Craft* was on demonstration. Persons interested in this sort of vivisection were able to see at close range just how the radio knife simultaneously cut and cauterized a piece of meat. The "sun motor" illustrated in the April, 1935 issue of *Radio-Craft* was demonstrated by means of artificial sunlight in the form of an electric bulb. The "talking book for the blind"—phonograph records that play without stop for 3 hours—also was on demonstration; a description of this epochal development appeared in the July, 1934 issue of *Radio-Craft*. "Artificial fever" devices illustrated in past issues of *Radio-Craft* also were shown. Numerous displays were based upon the use of the grid-glow tube and the photoelectric cell.

Equipment comprising a very involved type of "lie detector," an electric "frisker" for concealed weapons, crustless-bread baking apparatus, fox-piercing rays for ship use, picture transmission via telephone wires, the home radio printing press, the electric valet for the helpless, and the electric guide for the blind, all of which have been described in past issues of *Radio-Craft*, were here displayed.

A striking demonstration was presented in the operation of the Electrovox by musician and organist Lew White. Described as "The Music of 1940," the apparatus is said to be capable of producing 250 different musical tones.

### NEW DEVELOPMENTS

What may perhaps indicate the trend of radio receiver design was an all-wave, so-called "super-high-fidelity" set incorporating a "mid-night-blue mirror plate glass in chromium steel trim" as the entire front panel. (See Fig. A.) The actual apparatus was contained in a shallow cabinet in back of the panel.

Of interest to those who are sufficiently fortunate in their choice of residential location, there was demonstrated the ability to operate a radio set from what may be termed a radio-type windmill. The display utilized a new "Wincharner," and a high-quality battery-type receiver designed to operate from this wind-driven generator. (See Fig. B.) The "acoustical labyrinth"—a means for counteracting the resonance tendencies in a cabinet (see, "The Infinite Baffle," May 1935 *Radio-Craft*)—was shown in cross-section.

An even newer means of counteracting the tendency toward "boominess" in reproduction was shown to be through the use of "acoustic clarifiers." (See Fig. C.) In simple terms, one large and two small loudspeaker cones without driving mechanisms, are placed at strategic points inside the cabinet. These cones or "acoustic clarifiers" resonate at frequencies to which the cabinet is strongly resonant, and in so doing they counteract what would otherwise be objectionable over-emphasis of certain notes.

### AT RADIO-CRAFT BOOTH

Many of the actual instruments which served as the subjects of articles in past issues of *Radio-Craft* magazine were on display at the *Radio-Craft* booth. The metal tube Data Sheet which appeared on page 228 of the October, 1935 issue of *Radio-Craft* was enlarged to poster size, and actual tubes were placed over the respective types shown in the heading illustration. A novel motor—essentially, a galvanometer movement equipped with a commutator arrangement—requiring less than one-tenth milliamperes for its operation was shown connected to a crystal detector, and a tuning system resonant to various broadcast stations.

However, the device which caused the crowds to pack at this booth was the *Radio-Craft* "Oracle Record"—in simple, a phonograph record that purported to carry the answer to any and all questions asked by visitors at the Show! (See Fig. 2.) The manner of operating this device is here disclosed for the first time.

## THE EXPERIMENTER'S LABORATORY

(Continued from page 334)

And don't be afraid to make changes. You can always go back to a previous arrangement if the new one proves to be inferior. Nothing will be learned by a single trial. A single failure should only spur you on!

Keep an open mind—and don't be guided too much by the findings of others. Remember that "the 'fool' didn't know that it couldn't be done, so he went right ahead and did it."

That the experimental field is still wide open to alert experimenters is evident by reference to the following few items that occur to the writer as worthwhile developing.

A television system (complete, from transmitter to receiver)—having the picture quality of home movies, at a cost approximately equivalent to that of a good broadcast receiver—*which financiers will consider worth backing.*

Accurate "frequency meters" for checking equipment for use on 5 meters, and much less. American "midget" tubes (permitting the construction of tiny "personal" sets).

A speaker the size of a man's hand, which does not require a big haffle for low notes.

Inexpensive radio sets for receiving "amplitude-modulated" (static-free) programs.

"Cold" tubes (tending to greatly prolong the life of components by reducing cabinet heat).

Coils, for R.F. and I.F. circuits, measuring, say, 1x 1/2-in. dia. (with shielding) for compact assemblies.

Variable condensers (ganged) for tuning, with air-dielectric efficiency and mica-dielectric dimensions.

No less a personage than E. F. W. Alexander is said to have pointed out that an individual commercial laboratory necessarily is limited in its finances and its achievements, whereas, on the other hand, private laboratories—due to their daily interchange of diversified ideas and consequent aggregate knowledge—constitute a force much superior to that which any concentrated laboratory could offer.

Further, the aggregate sum expended annually by experimentally-inclined individuals reaches a staggering sum—and this tends to support a new field during its development period.

For illustration, in the early days of radio it is estimated that the country had the total sum of about 250,000 individuals who, in "playing" with the art and helping it to develop, spent an average of \$25 per year for the various materials then offered for sale! This mass purchasing supported the radio art in making the phenomenal strides that no other industry in any country has as yet equalled!

## Train Now for New RADIO Opportunities



**Get Into a Line Where There's Action—Every Day—And a Payday Every Week—You Be the Boss!**

Right now while hundreds are looking for work where there isn't any, the radio service field can use trained men. With the proper training and the necessary equipment, you can enter this field and make a comfortable living. We include with our course this modern set analyzer and trouble shooter without any extra charge. This piece of equipment has proved to be a valuable help to our members. After a brief period of training you can take the set analyzer out on service calls and really compete with "old timers." We show you how to wire shortwave receivers—analyze and repair all types of radio sets—and many other profitable jobs can be yours. Teaching you this interesting work is our business and we have provided ourselves with every facility to help you learn quickly yet thoroughly. If you possess average intelligence and the desire to make real progress on your own merits, you will be interested.

**Analyzer & Resistance Tester—Latest Design—YOURS Without Extra Cost**

### ACT NOW — MAIL COUPON

Start this very minute! Send for full details of our plan and free booklet that explains how easily you can now cash in on radio quickly. Don't put it off! Write today. SEND NOW!

RADIO TRAINING ASSN. of AMERICA  
Dept. RC-512, 4513 Ravenswood Ave., Chicago, Ill.

Gentlemen: Send me details of your Enrollment Plan and information on how to learn to make real money in radio quick.

Name.....

Address.....

City.....State.....

### ★ SERVICEMEN ★

Complete line Replacement Parts, Short Wave and All-Wave Receivers, Amplifiers, Test Equipment and Accessories. All at Rock Bottom Prices.

CONSOLIDATED RADIO PRODUCTS CO.  
Box 23 Northwestern Sta., Detroit, Mich. Dept 22K

FREE  
•  
NEW  
1936  
RADIO  
BARGAIN  
CATALOGUE

Please Say That You Saw It in RADIO-CRAFT



**SEND FOR THIS**  
**FREE**  
**CATALOG**  
 Check full of **BARGAINS** in **RADIO SETS**, Long and Short Wave Apparatus, Servicemen's Repair and Replacement Parts, Electrical Appliances, and hundreds of Miscellaneous Specials at **TREMBLOUS SAVINGS**. Get this big new Bargain Book. It's absolutely **FREE** without obligation—just send us your Name and address on a post card.  
**RADIO CIRCULAR CO., INC.**  
 225 Varick St., Dept. R. C., New York, N. Y.

**"Making an All-Wave Service Oscillator"**  
 As featured in October Radio-Craft Page 215. This unit includes facilities for making a P. A. system from any radio receiver. *Write for prices.*  
**SPECIAL OFFER ON SUPER SENSITIVE RELAYS**  
 Operates on 3 M. A.-D.P.D.T., silver contacts ..... \$1.95  
 S.P.D.T. 2 1/2 or 6 volt relays ..... 39c  
**ALUMINUM PANELS, CHASSIS MADE TO ORDER**  
 Wholesale Prices to the Home-Set Constructors, Experimenters  
 Headquarters for Parts—Since 1923  
**BLAN THE RADIO MAN, Inc.**  
 177 Greenwich St., New York, N. Y.  
**NO CATALOGUE—BUT LOWEST PRICES**

**EVEREADY SERVICE CEMENT**  
 "The Original Speaker Cement"  
 This is the best cement for replacing Speaker cones or repairing all radiating or tone passages. It can be used for other Radio work, such as sealing adjustments, cementing loose tube bases, etc. It is Vibration Proof and Fast Drying. Ask for it by name, at your jobbers. If he can not supply you, write us. Send for large circular of other Service Aids. List Price: 50c, per large bottle.  
**General Cement Mfg. Co., Rockford, Illinois**

**Newest ART CALENDARS**  
 Size 5 1/2 x 10 1/2 inches with your advertisement neatly printed as low as 2 1/2c each. Assortment of ten beautiful art subjects, also metal desk calendars, together with full details, mailed on receipt of 15c (refundable)  
 This is positively one of the most sensational advertising buys in the country today.  
**ATLANTIC CALENDAR COMPANY**  
 555 Jerome St. Brooklyn, N. Y.

**A-C CURRENT-ANYWHERE!**  
 WITH **KATO LIGHT PLANTS**  
 A little gas and a Kato AC plant enables you to operate AC radios, amplifiers, refrigerators and other standard household appliances. Saves 200 watts and up. Write for interesting descriptive literature on AC and DC models. Burn kerosene, 2 & 5 G.W. Diesel driven.  
**KATO ENGINEERING CO., Mankato, Minn., U. S. A.**  
 AC generators, converters for operating AC radios on 50 and 110 volts DC, and small light plants & battery chargers.

**30-15,000 CYCLES ± 1 D. B.**  
**MULTIPLE COIL** Each  
**Hum Free Construction** Net:  
**Audio Transformers \$3.75**  
 In Hum-Proof Cases  
 Single or Push-Pull Hitz and Low Equalizers in Alloy Case.....\$1.50  
 Hum Proof Alloy Case..... 0.75  
**ALLOY TRANSFORMER CO., 135R Liberty St., New York City**

**NOISE-REDUCING TWINS**  
**LYNCH HI-FI ASSEMBLED ALL-WAVE ANTENNA**  
 All ready to hang. Saves 90% of installation time. Amazing results. \$6.75 List  
 If your dealer cannot supply you, order direct, or write for folder.  
**LYNCH FILTERADIO**  
 Cuts out objectionable noise from the light line. Easy to install, simple to adjust. \$5.00 List  
**Arthur H. Lynch, Inc., 227 Fulton St., N. Y.**  
**PIONEER OF NOISE-REDUCING AERIALS**

**BIG NEWS!** The January, 1936, issue of Third Annual **SHORT WAVE RADIO NUMBER**. It's going to be one of the greatest issues of all times. Have your newsdealer reserve a copy for you.

The illusion created was as follows:

**THE "ORACLE RECORD"**

A large record was put on a turntable, the pickup placed upon it, and the apparatus put into operation. After a few turns of the record there were heard a short drum-snare, three loud, deep-toned bongos, and then a sepulchral voice saying, "The Oracle Record is ready to answer any of your questions." An announcer then invited guests to step up and speak their questions into a microphone. Answers were immediately forthcoming! The "record" was hard put to it when such questions were popped as: "When will war start?", "Who will win the World Series?", etc.!

**OPERATING DETAILS**

The equipment for accomplishing this novel effect was developed by Radio-Craft in collaboration with Ansley Radio Laboratories and comprised an A.C.-D.C. "dynaphone" (amplifier, loudspeaker, turntable, pickup and power supply) and associated equipment as illustrated in Fig. 2.

As is shown by the pictorial illustration, Fig. 2, the questions of the guests or attendant No. 1 as spoken into "mike" No. 2 traveled through a battery box into microphone amplifier No. 2, and from thence into a pair of phones worn by attendant No. 2 who functioned as the "voice" of the Oracle record!

The reply circuit was: mike No. 1 to microphone battery, to power amplifier, and then loudspeaker.

To the leads from microphone battery box No. 1 to the dynaphone were connected the leads from the crystal-type pickup. The record used was especially made for the purpose by "dubbing" or recording from a sound effects record, the previously-mentioned sound effects. Once the introductory sounds were "played," only the needle scratch remained for the balance of the record to complete the illusion of an oracle record.

**A PRECISION BRIDGE-TYPE CONDENSER ANALYZER**

(Continued from page 348)

grid and cathode of V1; choke Ch. in the plate circuit is tuned by C7.

The detector arrangement that includes neon lamp N1 has the advantage over the phone detector often used with bridges in that there is no loss of sensitivity in operation at 60 cycles. With a phone detector, the discrimination of ordinary phones and the well-known loss in sensitivity of the human ear at low frequencies make it difficult to obtain a good balance.

**THE D.C. LEAKAGE TESTER**

The leakage tester consists of a source of D.C. voltage (provided by Sec. 2 and V2), and N2 (used as a current indicator). The voltage required for condensers of various ratings is selected by the proper setting of switch S2.

(Component values are not given in the diagram, since the manufacturer wishes to insure perfect performance of the unit in having it serviced only by factory experts.—Editor)

The underside view of the analyzer.

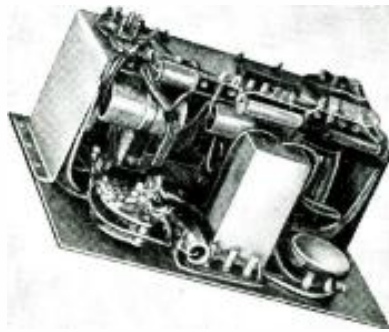

**New ALL-WAVE SIGNAL GENERATOR**

**BUILT Rugged TO STAND ABUSE**



Model 554-A

Dealer Net Price **\$14.40**

With all improvements of present day engineering. All frequencies are fundamentals and stabilized, completely shielded and tube modulated. Plug-in coils for present 5 frequency bands, 100-21,000 kc. (Any new frequency range can be added by new coil.) Extra large scale permits accurate frequency settings. Large, accurate calibration curves supplied. In Leatherette portable case complete with batteries and two No. 30 tubes. Dealer Net **\$14.40** Price.....

Readrite manufactures all types of testers used for servicing Radio Sets, including Set Testers, Tube Testers, Resistance, Continuity and Capacity Testers, Point-to-Point Testers and inexpensive Indicating Meters.



**MAIL COUPON NOW**

**READRITE METER WORKS,**  
 Dept. RC-12, Bluffton, Ohio.  
 Gentlemen:—Please send me more information—  
 .....Model 551-A .....Catalogue  
 Name .....  
 Address .....  
 City ..... State .....

Please Say That You Saw It in RADIO-CRAFT



## INTERPRETING CATHODE-RAY RESONANCE CURVES

(Continued from page 339)

Pattern No. 6 is an excellent response curve of a properly aligned receiver having "flat top" I.F. transformers. Note particularly that the two humps are equal in height and equally spaced from the central resonant-frequency line. (In any form of ordinary flat-top I.F. amplifier, the circuits should be adjusted until a resonance curve approaching Pattern No. 6 is obtained.)

Pattern No. 7 is similar to No. 6 except that one of the I.F. stages is slightly out of line. A slight shift in the tuning capacity in this transformer will make the curve symmetrical.

Pattern Nos. 8 and 9 are similar to No. 7 but with different proportions of misalignment. The same method of adjustment is valid here as for curve No. 7.

Pattern No. 10 shows the final over-all effect of staggering 3 I.F. stages. This consists of tuning the second I.F. transformer to exact resonance, the first I.F. transformer slightly to the high-capacity side of resonance, and the third to the low-capacity side. During such adjustments numerous unwanted humps appear when certain adjustments are carried too far, but each is seen immediately on the screen of the oscilloscope and the condition can be corrected at once. Each peak is definitely noticeable here and symmetrically arranged. Almost perfect amplification of all the side-bands which are passed is possible with an I.F. amplifier having a response curve such as this.

Pattern No. 11 shows the response curve of an I.F. amplifier having somewhat different staggering than that corresponding to No. 10. The response with No. 11 is such that the low audio frequencies receive slightly more amplification than the high notes.

Pattern No. 12 is unusual in the sense that it shows the extreme selectivity that may be obtained from some receivers having a straight-sided narrow-band tuning characteristic. If the set is tuned to a distant signal which is located adjacent to a channel occupied by a powerful local station, no interference should result. This pattern may also represent severe overloading of the tubes. In order to check this, the input signal should be reduced to a small value, and the change in slope produced should be noted.

Patterns Nos. 13 and 14 show several types of response curves that may be obtained when attempting to stagger 3 I.F. stages. The circuits need realignment to obtain the curves of either Nos. 10 or 11.

Pattern No. 15 indicates that circuit oscillation is present in the receiver. Note the wave formations, or ripples, in the response curve. These ripples arise from the fact that the oscillation alters the sensitivity of the receiver considerably at these points.

Pattern No. 16 shows the response of a single circuit which is tuned definitely to a frequency 4 kc. above the correct resonance frequency. It entirely cuts off one sideband. Such a circuit certainly needs realignment.

Pattern No. 17 shows the different response curves that may be obtained from high- and low-gain circuits.

Pattern No. 18 shows the response from an automobile vibrator "B" unit when the sweep frequency is different than the vibrator frequency.

Pattern No. 19 is interesting in that it shows the pattern produced when one pair of deflector plates is connected across the primary and the other pair is connected across the secondary, respectively, of the power transformer, the secondary voltage being reduced so that it equals the primary voltage. (The line may be made to slant in the opposite direction by merely interchanging the deflector plates used for the primary and secondary voltages.) The small areas that appear like smudges really represent transient voltages (voltages that are built up instantaneously due to various causes). The primary and secondary voltages from a power transformer that feeds a mercury-vapor rectifier tube may well simulate Pattern No. 19 because of the transients caused by ionization of the mercury in the rectifier. It is to eliminate these transient voltages that bypass condensers and R.F. filters are inserted in the circuits of these tubes.

20 TRANSMITTER

# TER CIRCUITS

THIS  
VALUABLE  
REFERENCE  
BOOK

FREE!

Complete design for 12 tested transmitter R-F section circuits and 8 modulator and speech amplifier circuits.  
Outputs ranging from the smallest to a big broadcaster.  
Not only the circuit designs, but complete parts specifications. Listing transformers, inductances and all component parts. A complete handbook on transmitter design!  
This valuable reference book sent you free. Just tear out this advertisement and send with 12c in stamps to cover mailing expenses in order to get your free copy. There is no further obligation. Hurry! The supply is limited.

STANDARD TRANSFORMER CORP.

856 Blackhawk Street, Dept. C Chicago, Illinois

STANDARD TRANSFORMER CORP., Dept. C,  
856 Blackhawk Street, Chicago, Illinois  
Please send me the Standard Manual of Transmitter  
Circuits. I am enclosing 12c in stamps.

Name \_\_\_\_\_

Address \_\_\_\_\_

City \_\_\_\_\_ State \_\_\_\_\_

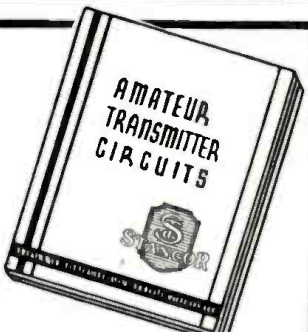

# Dependable

Suited to  
SERVICE MEN'S NEEDS

\* HIGHEST QUALITY \*  
SOUND ENGINEERING

## Ken-Rad Radio Tubes

THE KEN-RAD CORPORATION, Inc., OWENSBORO, KY.  
Division of The Ken-Rad Tube and Lamp Corporation  
Also Manufacturers of Ken-Rad Incandescent Electric Lamps





Glass or Metal Radio Tubes

### TURN SCRAP INTO MONEY



The new and revised edition of "Auto Power" with all the ten original specifications and ten new ones is now off the press. Convert old generators into A. C. and D. C. generators and motors with voltages of 6 to 400 volts, for power, light, welding, and radio operation. Create new generators adaptable for home, automobiles, or trucks. They can be driven by fan belt, wind or water. This book with complete illustrations, tells you how easily and economically these changes can be made. Also instructions for rewinding auto armatures. 350 definitions of electrical terms, etc. Already used and endorsed by thousands. Price \$1.00 postpaid.

AUTOPOWER Dept. C 414 S. Hoyne Ave. Chicago



Please Say That You Saw It in RADIO-CRAFT

# The Outstanding Microphone Buy of the Year

Now only **\$45.00** List



Brush B25 Microphone

Here it is . . . the new low price Brush Sound Cell Microphone for public address, amateur phone, remote pickup, sound car and dance band work. Typical Brush Sound Cell construction insures long life and satisfactory performance. Not affected by wind or severe changes in atmospheric conditions. Operates directly into high-gain amplifier. No input transformer. No distortion from close speaking. Fully guaranteed. Weight 3 ozs.—overall height 4 1/4 inches. Illustrated folder free on request. Send for a copy. If your dealer cannot supply you with this big new value write



## OSCILLOGRAPH

by NATIONAL UNION

3" OR 5" CATHODE RAY TUBE

EXCLUSIVE NEW DESIGN SWEEP CIRCUIT

FREE WITH NATIONAL UNION TUBE PURCHASES



The improved National Union Oscillograph incorporates an exclusive new design sweep circuit giving perfect linearity and synchronization for the visual inspection of individual wave forms from 10 to 250,000 cycles and permits inspection of waves to above 1,000,000 cycles. The only commercial oscillograph having an adjustable linear sweep circuit extending above the audio range. All controls on front panel except two position controls on side near front. Thirteen outstanding features. Get complete details and learn how you can own one free the easy National Union way.

**OTHER INSTRUMENTS**

Remember you can get many types of instruments free with National Union tube purchases. Send coupon for latest information.

NATIONAL UNION RADIO CORPORATION OF N. Y. 570 Lexington Ave., New York, N. Y. RU-1235

Send me complete information about free service shop equipment.  The N. U. oscillograph.

Name: \_\_\_\_\_  
 Street: \_\_\_\_\_  
 City: \_\_\_\_\_ State: \_\_\_\_\_  
 My Jobber is: \_\_\_\_\_

## A 10-TUBE SHORT-WAVE AMATEUR SUPERHET

(Continued from page 340)

output pentode and 5Z3 rectifier.

**Band Change:** individual coils for each band, picked up by a dependable 8-gang wave-change switch just like you find in all good broadcast receivers.

**Frequency stability:** individually shielded coils, all I.F. circuits air dielectric (not compression mica) tuned and trimmed, plenty of ventilation, and temperature isolation permit the set to stay "zero beat" on a good 20-meter signal for hours!

**I.F. Amplifier:** set at 25 microvolts absolute sensitivity, to place the limit of amplification due to inherent noise and thermal agitation, in the antenna circuit where it belongs, not as usual at the first-detector so as to lose weak signals in set noise. Two polyiron 465 kc. I.F. transformers, air tuned, and variable as to selectivity to suit your preference. Crystal I.F. transformer, dual tuned.

**Sensitivity:** variable, so that you can adjust it with two knobs from 50 cycles wide to 10 kc.—or a socket wrench pushed through two I.F. shield-can holes permits the I.F. transformer coupling and selectivity to be varied even further.

**Crystal Filter:** but a type that makes the usual garden variety look sick by comparison.

**Band Spread:** one tuning dial, accurately calibrated (yes, the builder can align it without any extra test equipment) with geared, no-slip, band-spread pointer on 200 divisions, 360 degree inside scale which accurately and positively re-locks. Fast and slow tuning ratios (23:1 and 130:1); spread, 1,000 deg. on 160 meters, 700 on 80, 400 on 40, 120 on 20, and 200 on 10. Effective feet (not inches) of dial space on the amateur and short-wave broadcast bands are supplied since 360 deg. of band spread equals about 1 ft. of dial space and 5 full turns of slow knob for 360 deg. band-spread pointer rotation.

**A.V.C.:** amplifies so it really does a job on weak signals; and speeded up so it also works on C.W. A switch cuts A.V.C. out for C.W., and in for phone if so preferred.

**Controls:** enough and no more; every one labeled as to what it does, and calibrated so you can tell that QSO just how much better he comes in tonight that he did with the old rig last night!

**R-Meter:** a sensitivity meter that lets you actually measure signals as weak as 5-0 microvolts absolute—and that's not an R9 signal—it's about R2 or R3!

**Construction:** the finish is polished chromium, like the finest custom-built jobs, yet it doesn't cost like gold; only a little more than black enamel. Assembly is simple indeed, for all low-frequency wiring comes all laced up in a complete color-coded cable—only the few "hot" bus-bar leads to be cut and fitted, and with complete instructions.

**Alignment:** the sensitivity meter is the output meter, in aligning the crystal, in a temporary circuit using no extra parts except that odd type 99 or 30 tube!

### THE "CONTROLS"

In the photo, the knobs, left to right, are crystal phasing and parallel switch; beat-oscillator switch; on-off switch; A.P. volume control; A.V.C. on-off switch; 5-position (one dead for "send") wave-change switch; tone control and sensitivity or manual volume control. The dial is shown 0-100—actually, it's outside carries

4 calibrated bands; the inside, 0-200 division, has a full-circle band-spread pointer scale.

The "dog house," behind the dial, contains the 4-gang, low-minimum-capacity, 200 mmf. tuning condenser, rubber mounted to kill microphonism (as is the whole chassis). At its right are the big copper shields housing the first R.F., second-R.F., first-detector and oscillator coils and trimmers for 3 bands—the high-frequency (16 to 33 megacycle) band being below the gang condenser. To the right, back to front, is the power transformer, 5Z3 rectifier, filter choke and 3 wet electrolytics (two are self-regulating, to save wear and tear on other circuits and parts—though all are safely rated).

The 4 tubes left of the "dog house" (back to front), are 6D6 first R.F., 6D6 second R.F., 6D6 suppressor-injected first-detector and 76 electron-coupled (yes, connected only to 6D6 suppressor grid, hence only electron-coupled to its load) R.F. oscillator. Left (front to rear) are: the first-I.F. polyiron-core transformer, crystal, 6D6 I.F. tube, second-I.F. transformer, 6C6 second-detector, 76 beat oscillator (not electron coupled; harmonics are not wanted), 6B7 amplified A.V.C., and 42 output pentode; phone jack and speaker plug on left rear.

The net result, is a honey of an amateur and short-wave broadcast receiver, nice and pretty in black enamel panel and polished chromium. If you like more chromium, a dust cover can be obtained to hide the works, dropping over everything but the panel.

### LIST OF PARTS

- Two coil assemblies, 465 kc.;
- One power transformer, No. 2067, 110 ma., 325 V. sec. P.T.;
- One filter choke, ch.;
- One 4 1/2-in. 2-speed "band-spread" airplane dial with "radio-silver" calibrated scale;
- One "radio-silver" control panel;
- Sixteen Hammarlund APC25 air trimmers, type D, 25 mmf.;
- Five Hammarlund APC100 air trimmers, type D, 100 mmf.;
- One Hammarlund MICS1000 trimmer, .001-mf.;
- Two Hammarlund SM15 star midgets, 15 mmf.;
- Four Continental Carbon resistors, 250 ohms, 1/2-W.;
- One Continental Carbon resistor, 500 ohms, 1-W.;
- One Continental Carbon resistor, 6,000 ohms, 1-W.;
- Two Continental Carbon resistors, 10,000 ohms, 1/2-W.;
- One Continental Carbon resistor, 3,000 ohms, 2-W.;
- One Continental Carbon resistor, 30,000 ohms, 1-W.;
- Five Continental Carbon resistors, 5,000 ohms, 1/2-W.;
- Two Continental Carbon resistors, 15,000 ohms, 1/2-W.;
- Four Continental Carbon resistors, .25-meg., 1/2-W.;
- Three Continental Carbon resistors, .5-meg., 1/2-W.;
- One Aerovox resistor, 7,500 ohms, 10-W.;
- One Readrite meter, 0-7 ma., No. TM108, with arrow left and window down;
- Six Readrite 1 1/2-in. black bar pointers;
- One McMurdo Silver "low min." condenser, 4-gang, 200 mmf.;
- One McMurdo Silver kit of: 1 A-B-C coils (2 R.F., first det. and osc.), 4 D coils (2 R.F., first-det. and osc.);
- One McMurdo Silver 17-F.B.O. coil;

The circuit of a "communications" set of superlative performance.

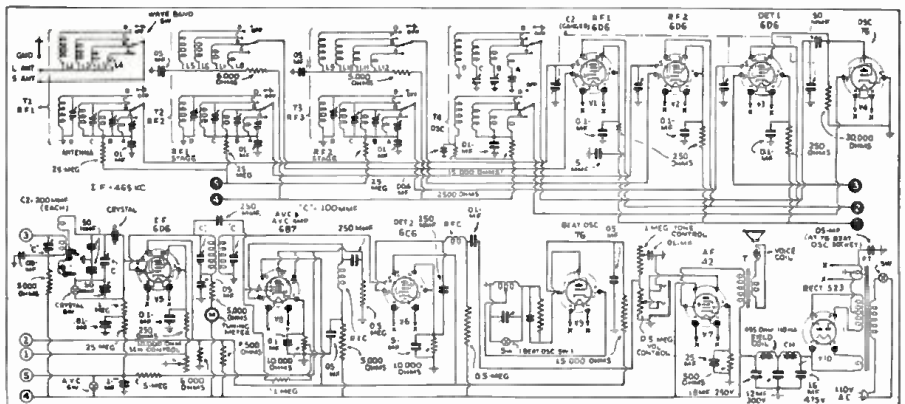

Please Say That You Saw It in RADIO-CRAFT

# THE NEW

## ANSLEY DYNAPHONE PLAYS 16-INCH RECORDS

Excellent for broadcast transcription records and all smaller discs of any speed. Microphone jack provided. AC-DC. Crystal pick-up (patented.) Weighs 35 pounds. \$89.50, ready for use.

**ANSLEY RADIO CORPORATION**  
100 W. 57th St., New York, N.Y.

## Tests METAL TUBE

The new Teft Tube Checker tests over ONE HUNDRED and FIFTY glass tubes in addition to the New All Metal and Metal Glass types.

It is small enough to be portable yet large enough for counter use.

Extremely accurate with the least number of adjustments.

For 105 to 130 volts A.C. 60 cycle current. **\$13<sup>50</sup>**  
\$13.50 F.O.B. Factory. \$3.50 deposit required with all orders.  
Write for free circular of this and other testing equipment.

**AL'S RADIO LABORATORIES**  
Farmington, Michigan

## Specify VAN Dials and Shunts

Accept No Other

Types 1-2-3x and 4 for Models 301-88-321  
Dials are Silvered and Etched on Brass  
Supplied by reliable dealers  
Folder on request

D. L. VAN LEUVEN 410 E. 15th St. New York, N.Y.

## DEALERS METAL TUBE

New 1936 "MODERN RADIO" RADIOS models using MG metal tubes now available. *Rock Bottom Prices.* Make real money with "MODERN RADIO." Send post-card for literature and prices. Be the first in your community to sell these new models.

**MODERN RADIO AND TELEVISION CO.**  
5220 N. Damen Ave. Dept. 10, Chicago, Ill.

## Care—Courtesy and Common Sense

The police safety campaign has obtained gratifying results. Accidents have decreased—public interest in this campaign has increased daily—all are becoming safety conscious. A strict observance of the slogan—Care—Courtesy and Common Sense, will reduce accidents and make the streets safer. It is the duty of all to cooperate in this worthy cause.

"TRAFFIC 'A'"

Beach Street New York, N. Y.

### Free Radio Catalog

Send for our free catalog of radio parts. 100 pages replete with bargains for Radio Servicemen, Experimenters, and Engineers. Buy with safety at Powertone. Prompt Shipments—Quality Merchandise—Dependable Service.

**POWERTONE ELEC. CORP.**  
221 Fulton St., N.Y.C.

### Correspondence Courses in RADIO and ELECTRICAL ENGINEERING

**ELECTRICAL ENGINEERING** covers complete electrical field. Most modern course. So simplified anyone can grasp quickly. **LOW COST!**

**RADIO ENGINEERING** Ultra-modern course in radio, public address, photo-electric work. Trains you to be super-service man, real vacuum tube technician. Run like college. Diploma given. Tuition only \$25, either course. Deferred payment plan.

**WRITE TODAY** for free copies of school catalogs, student magazines, etc. **SEND NOW!**

**LINCOLN ENGINEERING SCHOOL**  
859-B So. 37th St., Lincoln, Nebr.

**FREE POST CARDS** If you prefer to answer advertisements in RADIO-CRAFT on specially printed post cards, just write to the publishers and a supply of post cards will be mailed to you immediately. These post cards are sent to you absolutely FREE.

- One McMurdo Silver 17-G crystal autotransformer and shield;
- Six McMurdo Silver shield cans;
- Two McMurdo Silver R.F. chokes, 10 mhy.;
- Eight McMurdo Silver tube shields;
- One McMurdo Silver A-A-G binding post strip;
- One McMurdo Silver set 12 high-Q sockets with 8 tube shield bases, (4—6D6, 1—6C6, 1—6B7, 1—5Z3, 2—76, 1—42, 2 5-pin blank);
- One McMurdo Silver A.C. cord and plug;
- One McMurdo Silver A.V.C. on-off switch;
- One McMurdo Silver kit of hardware;
- One Sprague wet condenser, 475 V., 16 mf.;
- One Sprague self-regulating electrolytic condenser, 250 V., 18 mf.;
- One Sprague self-regulating electrolytic condenser, 300 V., 12 mf.;
- Seven Sprague condensers, No. TC15, .05-mf., 600 V.;
- One Sprague condenser, No. TC5, ½-mf., 600 V.;
- Seven Sprague condensers, No. TC11, .01-mf., 600 V.;
- One Sprague dry electrolytic condenser, No. HC5, 5 mf., 25 V.;
- Five Sprague condensers, No. TC1, .1-mf., 600 V.;
- One steel box and display radio-silver polished chromium pierced chassis, gang condenser shield, four partitions and bottom shield;
- One volume control, type N. .5-mex.;
- One tone control, 0.1-meg.;
- One sensitivity control, type G, 10,000 ohms;
- One jack, (4-spring, single-closed-circuit and single-filament-circuit);
- One switch, No. 9;
- Three mica fixed condensers, 50 mmf.;
- Five mica fixed condensers, 250 mmf.;
- One mica fixed condenser, .004-mf.;
- One piezoelectric mounted crystal, 465 kc., type Bc;
- Four Raytheon type 6D6 tubes;
- One Raytheon type 6C6 tube;
- One Raytheon type 6B7 tube;
- One Raytheon type 76 tube;
- One Raytheon type 41 tube;
- One Raytheon type 42 tube;
- One Raytheon type 5Z3 tube;
- One speaker with 7,000-ohm transformer, field 495 ohms, 110 ma., No. 68X, T.

## HOW TO MAKE HIGHER-FIDELITY RECORDINGS ON ALUMINUM

(Continued from page 340)

Figure 1B represents first, the curve of the amplifier plus a high-fidelity pickup; second, the curve of the amplifier while recording; and third, the curve of one of the better types of high-fidelity recording cutters.

While the curve of aluminum records is not included, it is lower at 8,000 cycles than 10 db. or 3.4 lbs. per linear inch. The amount of attenuation will vary somewhat in different rooms or studios. These rooms may be roughly placed in three classes. First, the room that is very much alive—one that has very little, if any, absorption; second, the room that may have a few covered chairs, a rug and some drapery; third, the practically "dead" studio with walls, floor and ceiling covered.

In the first case, good recording will be greatly hampered due to the reflection of sound from wall to wall, and from floor to ceiling, so that the sound waves that act upon the microphone diaphragm will be distorted out of all resemblance to their original shape.

In the second example of room construction, a better recording will result but large objects, such as chairs, tables, cabinets and other objects that protrude, either from the wall or up from the floor, will so break up the sound wave that the same note will be impressed upon the microphone at a considerable difference in time, causing distortion especially of the higher notes, so that the recording will be of poor quality.

The third type of studio exemplifies the trend of radio broadcasting stations towards scientific dampening of their studios, and that of the various commercial recording studios towards almost complete deadening. This writer's experiments have definitely pointed towards a composite type of studio—one that has some deadening at one end, and provision for adjustable sound-reflectors at the other. Of course, the microphone, piano, singer, or musical instruments should be located at the dampened end of the studio.



# 2 BOOKS THAT TELL YOU Everything ABOUT MODERN SERVICING

These two Ghirardi books are so important for you that you should not go another day without seeing them.

Ghirardi's MODERN RADIO SERVICING, although out only a few months, has called forth so much unsolicited praise from practical service men that we are conservative when we say it is not only the best book in this field, but the only practical book that covers it thoroughly and gives so much essential information. You'll find described here every kind of testing instrument and method—all the latest dope on Cathode-Ray Oscilloscopes, etc. The invaluable construction data on these instruments will enable you to make your shop thoroughly up-to-date. Everything connected with servicing is here—alignment of receivers, elimination of noise and interference, auto radio, etc., etc.—even to a long chapter on how to sell and advertise your service.

Ghirardi and Freed's RADIO FIELD SERVICE DATA AND ANSWER BOOK is the Supplement to MODERN RADIO SERVICING to take with you out on your servicing jobs. It has tabulated data of all kinds arranged for immediate reference—trouble symptoms and remedies for over 750 receivers, a complete table of i.f.'s for all superhets (2,790 in all!) and 25 other useful tables and charts. It also contains the answers to the numerical problems appearing in MODERN RADIO SERVICING.

You need these two books right now. The day you get them you'll be able to do your radio work quicker and better—and to do many service jobs you never could before. They'll put hundreds of new ideas into your head and new money into your pocket! Get your copies now.

Introductory Combination Offer  
★ MODERN RADIO SERVICING AND ★ RADIO FIELD SERVICE DATA ★  
ONLY IF PURCHASED TOGETHER

**FREE CIRCULARS**

Mail This Today

**RADIO & TECHNICAL PUBLISHING CO.**  
45 Astor Place, New York, Dept. RC-12

Please send your Combination Offer. \$5. enclosed (\$5.50 foreign).

Please send free literature on the books described in RADIO-CRAFT.

Name .....  
Address .....  
Occupation .....



Please Say That You Saw It in RADIO-CRAFT

# TRY THIS NEW SPEAKER ASSEMBLY

**FIND out for yourself about tremendously increased measure of performance, adaptability and good appearance embodied in this amazing new outfit for every indoor requirement. All-aluminum baffle housing, adjustable wall mounting bracket, improved speaker efficiency with feed-back practically eliminated. Like all Toledo equipment it is dependable first, last and all the time. Write for catalog, prices and data on the laboratory-built TOLEDO line. Learn about our liberal free 5-day trial.**



## OTHER TOLEDO PRODUCTS

- Portable Sound Systems • Electro-Dynamic Units • Carbon Microphones • Amplifiers • 4, 5 and 6 Ft. All Aluminum Natural-tone Trumpets • Field Exciters • Air Column Horns • Low and High Frequency Units For Wide Range Theatre Use

**TOLEDO SOUND EQUIPMENT LABORATORIES**  
Formerly Bud Speaker Co.  
1155 JACKSON STREET • TOLEDO, OHIO, U. S. A.

## MEN WANTED—SELL RADIOS SPARE TIME—BIG PROFITS

Since 1921 I have sold radios exclusively through trained radio service men. Not the type of prize cutting radios widely advertised and sold in stores but . . . radios of a quality which only radio men can appreciate.

I need more men in my organization . . . men who actually know radio values because no other type of man can sell my quality of radio. Give me your spare time . . . evenings, and I'll show you radios which will sell by very simple demonstration.

I prefer one man in each community . . . operating on an exclusive basis. My literature shows no prices . . . I feel that you, and you alone, should set your retail prices. I do not send wholesale prices direct to customers . . . I do not sell through the average retail store. I endeavor to sell my radios exclusively through radio service men.

As far as I know, I'm the only one selling in this manner. I have never sold in any other way since the day I started . . . May 1, 1921. Today nearly 8000 radio service men handle my radio . . . many of these men have been with me steadily for ten years and more.

I make no junk . . . I make no attempt to build the lowest priced radio but I can give you quality which you can stand behind and . . . keep the confidence of your customers. I make a complete line of electric, battery and auto radios from five to sixteen tubes.

I know the radio service man's problem. There is real money to be made in selling radios if . . . you get lined up right but it will never be with the regular advertised lines on which stores are continually slashing prices . . . Just when you least expect it, my prices are never cut.

Send for illustrated literature and wholesale price list. Prove to me you are a radio service man. You'll find my literature very interesting . . . write today.

**J. MATHESON BELL, INC.**  
308 W. Randolph St., Dept. "E", Chicago

## SERVICEMEN

NO LONGER NEED YOU PEAK RECEIVERS BY EAR

### NEON OUTPUT INDICATOR

Connects direct to voice coil. Complete with test leads and instructions. Circular on request.

LIST PRICE \$6.50 NET

**GLOBE MFG. \$3.85**

Box 4561-Phila. Pa.

## SERVICING THEATRE SOUND SYSTEMS

(Continued from page 312)

in distinctness. A variation greater than 0.1-per cent will be noticeable in the overall frequency response.

Incorrect speed may be attributed to incorrect line voltage on the motor, defective motor speed controls, worn pulleys, slipping belts or loose chain drives. These troubles may be easily located with the aid of the operator.

### THE OPTICAL SYSTEM

The optical system (Fig. 3B) in the sound head (consisting of the exciter lamp, optical barrel and photo-cell) requires the same careful attention and delicate adjustments as one would give to the finest watch, in order to obtain the full frequency response with a minimum of distortion.

The exciter lamps should be operated at exactly the rated current and voltage so that the scanning beam will be full-bodied.

In focusing the exciter lamp (Fig. 1.), place a white card in front of the photo-cell, and after having removed the film from the mechanism, inspect the sound aperture for dirt; and the lens in the optical barrel and the exciter bulb for fingerprints or cloudiness. Lamps with blackened glass or sagging filaments should be replaced before attempting any adjustments. The life rating on exciter lamps is 100 hours.

Some machines are not constructed for back and forward adjustment of the exciter lamp bracket, but when they are, run the assembly forward until the filament image shows on the white card, then move it back until the image just disappears, leaving a pure white light. If the light on the card is tinted with blue or yellow across the top or bottom, adjust the assembly up or down until the coloring disappears, leaving a white light. Horizontal adjustment will eliminate the side shadows.

Manufacturers have recently introduced portable sound equipment which uses a simple oscillator circuit for the exciter lamp supply (Fig. 3A). A type 45 tube generates an R.F. current on the order of 15 kc. The R.F. voltage variations are then above the audible range. This system avoids the necessity of rectification and batteries. If the lamp fails to light, or after a period of operation goes out, open or shorted condensers, coils and defective resistors in the oscillator circuit will cause trouble, as will a defective rectifier or oscillator tube.

The optical barrel (Fig. 3B) consists of a tube with a condenser lens system in the end to the exciter lamp and an objective lens system in the opposite end. Between the two is the aperture, or slit for making the scanning beam. The condenser lens system collects the light rays from the exciter lamp and projects them in concentrated form onto the aperture so that the light entirely covers the slit. This is accomplished by having the condenser lens focal point just past the aperture. The sharp edges of the aperture cut off the beam of light a few ten-thousandths of an inch larger than the beam that impinges upon the sound gate. After the light passes through the aperture, it is reduced by the objective lens system, so that at the focal point (the sound gate surface) the scanning beam is .001-in. thick, vertically. The sound gate is .08-in. wide, slightly smaller than the film sound track which is .1-in.-wide, allowing .01-in. for lateral clearance on each side of the track.

The ideal way to align the optical barrel is to use frequency film (Fig. 2B) and a microammeter in the photo-cell circuit, "tuning out" the light until the cell draws a minimum of current (Fig. 5). The frequency at which

most optical systems are aligned is 9,000 cycles per second. If the service engineer uses a white card instead of the microammeter he should proceed as follows: after properly threading the test film into the sound head, slowly rotate the flywheel by hand until one line of the frequency film is exactly centered in the spot of light on the white card. Then move the barrel in or out until the existing light is obliterated, being sure of course, that the scanning beam is perfectly horizontal on the sound grate.

Pulling the frequency film slowly through the sound head will also show incorrect alignment. If the shadows of the frequency lines move downward, the optical barrel is too far away from the film. If the shadows move upward, the barrel is too close to the film.

Although it is not considered ethical, an emergency adjustment of the optical barrel may be made while the machine is running, providing the sound head is so constructed that the sound gate may be seen. Cigarette smoke blown into the path of the light beam will show up the point of focus (Fig. 6), and by moving the barrel in or out until the focal point seems to blend into the edge of the film, a fair adjustment may be reached. Be sure that while this adjustment is being made the scanning beam remains perfectly horizontal on the film.

Check to see that all adjusting and locking screws are tight, and that the optical barrel does not slip in the holder. Inspect connections to the PE. cell for good electrical and mechanical contact, as well as the prongs on the cell base for oil or corrosion.

With the aid of a dental mirror (placed in back of the sound gate) guide-roller adjustments may be made when the machine is not running, but when running the sound track can be centered by "tuning out" the frame line or sprocket hole noise. The frequency test film also has a "buzz track" on it for guide-roller alignment. This consists of two tracks, one 400 cycles and the other 1,100 cycles, and when the rollers are properly aligned, neither one will produce sound.

A flutter in the sound may be traced to a bent sound head drive shaft. Although it may not be noticeable to the eye, the shaft may be out enough to cause an alternate pull and sag on the film at each revolution, causing the above-mentioned flutter. Frying-like noise traced to the sound head may be caused by defective photo-cells, corroded joints, arcing filaments in the exciter lamps and poor grounds, particularly in the PE. cell cable. Some systems use an exciter lamp current rheostat in the sound head. Pitted contacts on the rotating arm, or worn resistance strips will cause a flickering or intermittent light source.

Incorrectly adjusted tension shoes will cause the film to buckle and weave; however, in most cases, this and other mechanism adjustments will be made by the operator. For perfect synchronization with the picture, the scanning line should be 1 1/2 ins. (measured on the film) below the picture aperture.

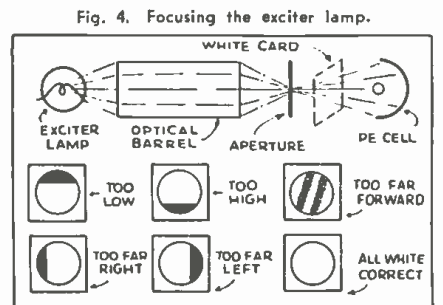

Fig. 4. Focusing the exciter lamp.

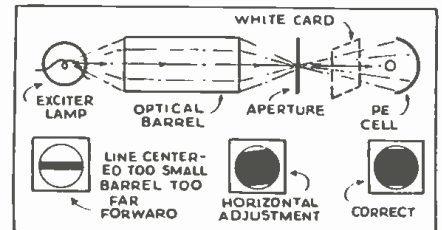

Fig. 5, above. "Tuning" the light.

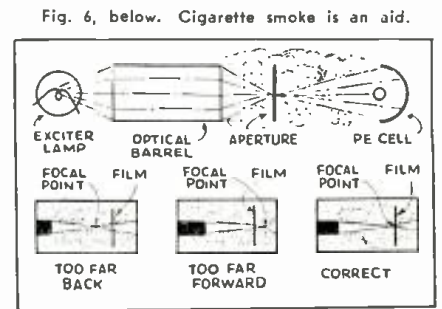

Fig. 6, below. Cigarette smoke is an aid.

Please Say That You Saw It in RADIO-CRAFT

## HOW TO MAKE A SIMPLE COIL WINDER

(Continued from page 341)

of the feed bar to the shaft. The end of the feed-drive shaft is drilled and tapped to receive a common switch point. The soft brass head of the switch point is filed to a wedge shape. To attach the feed bar to this shaft, a common 1/8-in. hexagon nut is drilled 3/8-in., to snugly fit over the shaft. Holes are drilled and tapped in two sides of the nut for the double purpose of making it tight on the shaft and to attach the feed bar. The feed bar is made of a strip of 1/8-in. bakelite, and a piece of an old jack frame is used to connect the bakelite to the shaft. The outer end of the bakelite is slotted with a slanting cut the bottom of which comes directly over the center of the coil.

Another bearing similar to the others is needed for the feed-drive shaft to slide back and forth through, and the same care should be exercised in making it. To complete this portion of the assembly we need only a means for holding the shaft against the cam, and this is done with the two springs. These springs are attached to the shaft with another 1/8-in. nut drilled out, and drilled and tapped for set screws through opposite sides. The ends of these set screws are used as hooks to hold the ends of the springs, and the position of the nut on the shaft governs the spring tension. This tension should be just tight enough to hold the end of the shaft against the cam during the entire revolution but no tighter than necessary. The springs have another function, that of holding the shaft so as to prevent turning. The other ends of the springs are attached to the wooden block with small screw-eyes.

Most any arrangement may be used to provide a bobbin for the coil to wind on. In this winder, a piece of bakelite tubing was at hand that had an inside diameter of slightly less than 3/8-in. This was reamed out until it fitted snugly over the shaft. Nothing further was needed but if some other idea is used the only point which needs attention is that the bobbin must not wobble as it revolves. It may be found necessary to use an extra bracket to support and steady this shaft, depending on the excellence of the main bearing.

The spindle which holds the spool of wire used for our coils should be so constructed as to allow the wire to unwind smoothly and evenly. Some adjustable means for varying the tension on the wire as it is fed should be constructed and used. Springs were tried with partial success and the final design makes use of a piece of soft felt placed against the spool.

### THE REVOLUTION COUNTER

Until now no mention has been made of the very necessary revolution counter. So many home-made counters have been described in the various magazines that no details will be given here. The writer happened to have a small Veeder counter in the junk box and so it was pressed into service.

The job is not quite done even after the winder is complete, as some practice in winding seems quite necessary. We have tried to cut this practice down for you by stressing the points most directly related to success in winding good coils.

In winding, try to wind with an even, smooth speed and do not stop in the middle of a coil as you will find it almost impossible to get started again without having the coil collapse. This suggests the use of idlers to operate against each side of the coil and possibly it might be done but our results were far from satisfying, so the idea was dropped. Different sizes of wire will require a change in the adjustment of the wire tension.

It might be well to suggest a method of holding the coil together while taking it off the bobbin and, before the coil dries, to cement the turns in place. A piece of coarse thread may be laid along the bobbin and the coil wound over this. However, in using thread, when we attempt to tie our coil, the thread tends to cut into the coil and pull the turns out of place. A better plan is to use a small strip of adhesive tape, bringing the ends up over the coil when it is completed. We find that the completed coils slip off of the bakelite bobbin easily, leaving the bobbin in place on the shaft.

# STENTORIAN

## SOUND AMPLIFIER NUCLEUS

*Remember*—build your Amplifiers the STENTORIAN way—for the finest results at the lowest cost—Power Supply Units are the nucleus—the very backbone of Sound Amplifiers!

You'll find that STENTORIAN way Sound Amplifiers give strong, clear, brilliant volume for auditoriums, ballrooms, convention halls, lodge halls, political rallies, banquet programs, night clubs, taverns, office and factory call systems, depot train call systems, truck and auto advertising, athletic fields, race track announcements, concession barkers and the like.

The STENTORIAN NUCLEUS includes perfectly matched power transformer, chokes, audios, and outputs, plus an attractive black wrinkle-finished chassis equipped with lettered output and input terminal strips and marked tube sockets—for 6, 10, 15, and 30 watt Amplifiers. Class A and AB amplification. 2.5 and 6.3 volt tubes. Nuclei for two additional 6 and 15 watt Amplifiers—using the new All Metal tubes; for crystal or condenser mike Pre-amplifiers; and for small Class B Battery Amplifier.

Don't delay—send now for full details!

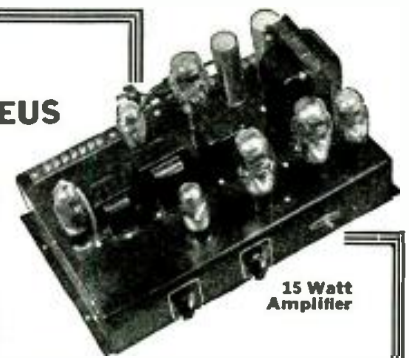

15 Watt Amplifier

*Free for the Asking!*

Interesting fully illustrated bulletin on the STENTORIAN Sound Amplifier Nucleus and name of our nearest distributor.

THE "STENTORIAN" WAY IS THE MOST ECONOMIC WAY FOR QUALITY SOUND AMPLIFIERS.

**GENERAL TRANSFORMER CORPORATION**  
504 South Throop Street Chicago, Illinois  
Manufacturers of Replacement Units



... America's Original Radio Engineering School  
Offers for the First Time A New Home-Study

Course in **Service** and Public Address

### ENGINEERING

This course was personally prepared by Mr. E. H. Rietzko and the faculty of CREI. NOT to bring new servicemen into the already crowded field, but to improve the status of the professional serviceman. This course is practical right from the first lesson... it starts where other Service Courses end. The Serviceman today must have a keener knowledge of fundamentals to keep in pace with the many new improvements in radio—that's where this course will pay dividends to you.

**The Finest Home-Study Course for Servicemen—at a Price You Can Afford**

CREI is recognized as the finest radio school in the country, and we believe this to be the finest Service course. It is not for beginners—it is to help men who are already Servicemen but who are ambitious to be Service engineers. The price is right, and special terms are available on request.

*Just Off the Press!*  
**NEW 48-PAGE ILLUSTRATED BOOKLET FREE!**

This new catalog fully describes our various Home Study and Residence School courses in Practical Radio Engineering. Sent FREE to anyone who requests it. Write today.

If interested in our Service Course ask for special Service Course Supplement which gives complete details and outline of course.

## CAPITOL RADIO ENGINEERING INSTITUTE

14th and Park Rd. Dept. RC-12 Washington, D. C.



### EILEN SW5 RECEIVER

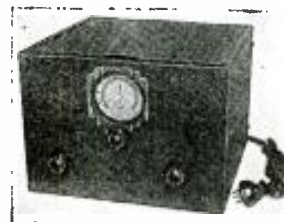

A powerful, sensitive, and efficient SW receiver that WILL produce the RESULTS: 1 set 6196 - 6B7 - 12A7 tubes as aperitivic IIF amplifier, screen grid regenerative detector, triode amplifier, power pentode audio amplifier, rectifier and complete built-in power supply. Operates entirely from

110 V house lighting current. Beautiful, large, illuminated airplane type vernier dial—tremendous volume—smooth regeneration control—BAND SPREAD TUNING—beautiful heavy black shroud finished metal chassis and cabinet and RESULTS that make this an outstanding value which the beginner as well as the experienced SW fan cannot afford to miss. SOLD ON MONEY BACK GUARANTEE. KIT of parts, including coils for 10-200 meters, simple instructions and diagram Airtube matched tubes... 2.45 Headcast coils... 1.25 SPECIAL: Complete KIT, cabinet, tubes & BC coil... 11.35 Labor for wiring & testing, ready to use, extra... 1.00 Magnetic speaker, extra... 1.15 36 hour shipments. Deposit on COD orders. Send for FREE catalogue. EILEN RADIO LABORATORIES Dept. RC12 136 Liberty St. New York, N.Y.

**CORNELL** ★ **DUBILIER**

Quality condensers of every type and description for every requirement.

Electrolytics: Manufactured by the high formation process—and triply sealed.	Paper condensers: Dykanol oil impregnated and filled in hermetically sealed steel containers.
--	---

Mica Condensers: Standard since 1910 these condensers incorporate the latest designs in condenser construction.

Write for details, see catalog No. 128.

**STANDARD** ★ **SINCE 1910**

**CORNELL-DUBILIER CORPORATION**  
4347 BRONX BOULEVARD  
NEW YORK

Please Say That You Saw It in RADIO-CRAFT

**FREE**

VALUABLE NEW CATALOG  
Filled With The Latest  
**RADIO PARTS**  
**AMATEUR SUPPLIES**  
**P. A. EQUIPMENT**

Just Off The Press!  
Send for YOUR Copy TODAY

**NEW DEVELOPMENTS!**  
**NEW APPARATUS!**  
**NEW LOW PRICES!**

Every Radio Man Will Need New Equipment for Servicing The NEW METAL TUBES. You'll Find It in This New Catalog.

**Famous Testing Equipment**  
**SOLD ON EASY TERMS**

The Latest Triplett—Readrite—Supreme—R.C.A. Clough Brengle and Triumph are All Included.

Write for Catalog 653 RC  
**SEARS, ROEBUCK and CO., Chicago**

**IT'S DIFFERENT**  
**IT'S BETTER . . .**

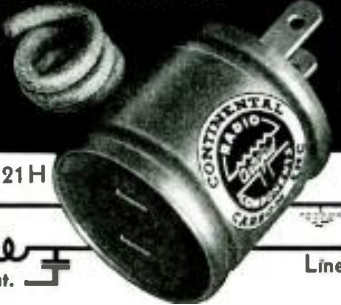

R21H

Radio

to Set Ant.

Line

**. . . A Short and Long**  
**Wave Lamp Socket Aerial!**

Ask your Serviceman for free demonstration  
Send for Bulletin 103 with complete information

**CONTINENTAL CARBON Inc.**

13914 Lorain Ave., Cleveland, Ohio  
Canadian Factory Toronto, Ontario

NETWORK OF SERVICE  
**American Junior**  
**Red Cross**



## ANNOUNCING THE WINNERS IN RADIO-CRAFT'S "IDEAL RADIO SERVICE SHOP" CONTEST!

(Continued from page 345)

### PRIZE-WINNING LETTERS

Available space permits printing only the following two prize-winning letters. However, it is probable that some interesting articles will appear shortly in *Radio-Craft*, based on a resumé of the remainder.

#### 1ST PRIZE

Contest Director:

Well, here's the "Dream Shop" and it's been fun doping it out. Not so much of a "Dream Shop," either as I have been fortunate enough to have available most of the equipment described here.

Realizing the "short comings" of some of the equipment I have used, I have pensively elaborated upon it to make it meet the requirements of this Utopian service laboratory.

The oscilloscope-oscillator-frequency modulator combination, for instance: how many of us, after going through all the trouble of visually aligning a receiver, have then found the intermediates so far from their specified frequency that it was impossible to make the oscillator tuning correspond to the set's dial marking? Why doesn't some one put out an oscillator calibrated for use with a frequency modulator? Or why not build the two in one unit? Or does some one?

How many of us have "popped" two or three electrolytics in an auto-"B" supply before tumbling to the fact that auto-"B" vibrators can produce some enormous voltage peaks? Or wondered if we really had A.V.C. voltage? A really flexible vacuum-tube voltmeter would be heaven's gift to the harassed Service Man.

It will be noted that I have included a library in my "Dream Shop." A good service library, containing carefully compiled service data and really good text books is, in my opinion, just as important a part of the equipment of the modern service laboratory as are the ohmmeter and voltmeter.

Following is the list of equipment, none of it fancy, but all of it essential to those of us who would achieve "Utopia" of radio service.

#### I Analyzer

- Portable and self-contained.
- Selector-portion requirements:
  - Rotary switch, free-reference-point type.
  - Point-to-point voltage analysis.
  - Point-to-point resistance analysis.
  - Point-to-point circuit insert.
  - Current drawn by any element.
  - Circuit insert in series with any element.
- Meter requirements:
  - D.C. volts, all ranges 0-10 to 0-1,000.
  - D.C. amps., all ranges 0-1.0 ma. to 0-1.0A.
  - Ohmmeter, all ranges 1.0 ohm to 10 megohms.
  - A.C. volts, all ranges 0-5 to 0-1,500.
  - All ranges brought out to external terminals.
- Flexible scales (not necessarily confined to one or two meters).

#### II Tube Tester

- English-reading type.
- Hot-cathode short test.
- Test all types.
- Simple operation.

#### III Test Panel (for test bench)

- D.C. voltmeter, all ranges 0-10 to 0-1,000.
- A.C. voltmeter, all ranges 0-5 to 0-2,000.
- Wattmeter, dual-range, large scale, 0-150 to 0-300.
- Capacity meter ranges 0-0.5 and 0-10 mf.
- Electrolytic condenser test.
- Neon condenser-leakage test.

#### IV Cathode-ray Oscilloscope

- 5-in. tube.
- Frequency modulator and oscillator in one unit.
- A.F., pure R.F., and modulated R.F. oscillator signal.
- Calibrated attenuator on oscillator.

#### V Oscillator

- All-wave. Fundamentals.
- A.F., pure R.F. and modulated R.F. signals.
- Variable A.F. with calibrated output and delivering a sine with no humps.
- Directly-calibrated dial.
- Self-contained power supply.
- Built-in output meter with suitable ranges.

#### VI Condenser Decade Unit

- Ranges 100 mmf. to 10 mf.
  - Positive-contact switches and terminals.
- VII Resistor Decade Unit
- Range 1.0 ohm to 10 megohms.
  - Positive contact switches and terminals.
- VIII Grid-dip Meter
- Directly-calibrated dial.
  - Range 100 to 1,500 kc.
  - Set of calibrated inductances for low-value condenser measurements.
- IX Vacuum-tube Voltmeter
- Self-contained A.C. power supply.
  - Ranges 0-5 to 0-1,000 V., peak and R.M.S.
- X Library
- Complete set of service manuals (such as Gernsback's or Rider's).
  - File of manufacturers' service notes.
  - File of radio trade and technical magazines.
  - Manufacturers' tube manual (such as the RCA Radiotron Handbook).
  - Several good text books by such authors as Ghirardi and Freed, Duncan and Drew, Morecroft, Terman, Van der Bijl and others.

With an array of equipment such as this, what more could a Service Man's little heart desire? (Maybe more customers, eh?)

E. E. Sayre,  
33 Union Ave.,  
Maplewood, N.J.,  
(Aug. 14, 1935)

#### 2ND PRIZE

Contest Director:

My Ideal Service Shop would be arranged in three sections.

First Section.—The first section would have tube-checking apparatus and a ready supply of tubes, the checker being of the English-reading type, capable of making both quality and short-leakage tests.

Racks for displaying the parts used in midget and quality sets, as well as advertising material would be conveniently located. A shielded booth with glass windows containing line-up apparatus would be located where the customer could see his set adjusted by precision apparatus. This equipment would include:

- Accurate R.F.-I.F. oscillator, from 50 to 60,000 kc., and having a frequency wobbler for use with a cathode-ray oscilloscope.
- A.F. oscillator for modulating above, from 15 to 20,000 cycles.
- Calibrated vacuum-tube microvoltmeter.
- Cathode-ray oscilloscope, with horizontal and vertical amplifiers, and linear sweep circuit.
- Necessary alignment tools.

Second Section.—The service department of the second section would include the service bench and test panel. The test panel would have built-in:

- All-wave, grid-dip oscillator.
- Vacuum-tube voltmeter.
- Meters and switching arrangements for the following ranges:

E.M.F. (A.C. and D.C., at 10,000-ohms-per-volt) — 0-0.1- 1.0-10-50-100-250-500-1,000-2,500-5,000-10,000 V.

Current (D.C.)—0-1.0-100 microamps.; 0-1.0-10-50-100-250-500 ma.; and, 0-1.0-10-25-50 A.

Current (A.C.)—0-100 microamps; 0-100-500 ma.; and, 0-1.0-5-10 A.

Resistance—0-10-100-500-5,000-50,000 ohms; and, 0-0.5-1.0-10-50-100 megohms.

Impedance—0-500-1,000-10,000 ohms; and, 0.1-1.0-10 megohms.

Capacity—1-100-1,000 mmf.; .001-0.1-mf.; .05-5 mf.; .25-25 mf. and 1.0-100 mf.

Inductance—0.1-10-500 mhy.; and 0-10-500-10,000 hy.

Decibels— -10+20 db.; +15+45 db.; +40+70 db.; and, +70+100 db.

Watts (at about 1,000 cycles)—0-10-100-1,000 W.

- Condenser tester (to test leakage, shorts and opens).
- Wheatstone bridge.
- Tube tester.
- Free-reference-point analyzer and cables.
- Speaker, and matching circuits.
- Parts-substitution unit.

The bench would include:

- A.C.-to-D.C. rotary converter.
- Compressed-air blower.
- Necessary tools.
- Service manuals.
- Case records.

Please Say That You Saw It in RADIO-CRAFT



**BIG 1936 WHOLESALE**



**CATALOG FREE**

164—Radio, Electrical and Refrigeration Equipment at lowest prices. A catalog of great value to every dealer, service man and amateur. Complete sets, parts, amateur and commercial apparatus. Write today.

**BURSTEIN-APPLEBEE CO.**  
1012-14 McGee St., Kansas City, Mo.

**Tests the NEW METAL TUBES**



**\$1350**

The new Tefft Tube Checker accurately tests over one hundred and fifty different tubes in addition to the new metal tubes. Write for illustrated circulars.

**THE TEFFT RADIO COMPANY**  
PLYMOUTH, MICH.

**BUILD IT YOURSELF**

You can build this Trailer with ordinary tools easily from our step-by-step constructional sheets and large sized blueprints. Finest designed Trailer in existence, sleeps 4, Toilet, Shower, Electric Light, etc. Save 75% of the cost by building it yourself. Send 25c for plans sheet, illustrations and details.



THE PLAN SHOP, 910 Palmolive Bldg. Chicago, Ill.

**QUALITY RADIO SUPPLIES**

1936 Catalog featuring hundreds of new items x-mitter, receiver and transmitter parts—television and short wave equipment, apparatus and items of interest to all radio enthusiasts. Send 10c in stamps or coins to cover cost of handling and mailing.

**INSULINE CORP. OF AMERICA**  
25 Park Place New York, N.Y.

**SAFETY CAMPAIGN ATTENTION**

Do you know that CARE, COURTESY and COMMON SENSE mark the character of a careful driver

It Prevents Accidents and Saves Lives  
**POLICE DEPARTMENT CITY OF NEW YORK**  
LEWIS J. VALENTINE  
4th PRECINCT Police Commissioner

**Radio Dealers & Servicemen!** **S. O. S. CINEMAPHONE**  
16 and 35 m. m. Talking Picture Equipment  
Lowest Prices! Free Literature! may also be ideally used for Public Address  
**S. O. S. CORP. 1600 B'way., N. Y. C.**

**RADIOS..SAVE UP TO 50%**

**DEAL DIRECT.** Factory Price. Many models to select from: A.C.-D.C. All-wave, Farm, Car and new metal Tube Models. Your name and address on postcard brings you NEW 24-page 1936 Bargain Catalog in colors FREE. Get details of 30-DAY TRIAL plan and Agent-User proposition. **Goldentone Radio Co., Dept. 216 8780 Grand River, Detroit, Mich.**

If you are interested in servicing electric refrigerators, write today for complete details about the Second Volume to the OFFICIAL REFRIGERATION SERVICE MANUAL. Address, **GERNSBACK PUBLICATIONS, Inc., Dept. RC, 99 HUDSON ST., NEW YORK, N. Y.**

(6) Rack for turning and handling heavy chassis.

A supply of parts would be kept on handy shelves, and attention paid to proper illumination.

The office would have complete files of service records; necessary textbooks; and customary office, and bookkeeping essentials.

**Third Section.**—The third section would park several cars, and would have necessary equipment for installing and testing (preliminary) auto-radio sets, and would include a vibrator-“B” tester.

Portable equipment would consist of a complete analyzer, and necessary tools.

The truck would carry a P.A. system.  
**Theodore R. Sayre,**  
1136 Woodruff Ave.,  
Hillside, N.J.  
(Aug. 6, 1935)

Special attention must be called to a number of technicians whose letters were of exceptional merit, as follows:

**HONORABLE MENTION**

- Henry Bal, Box 3, Roseville P.O., Newark, N.J.
- Harvey H. Schock, Reading, Pa.
- Lewis E. Rapp, Hammond, Ind.
- John Reuter, Aurora, Ill.
- Richard Davis, Ramsey, Ind.
- R. E. Callicotte, Laramie, Wyo.
- Edward T. Forth, Wellington, New Zealand.
- Wm. J. Kelly, Chicago, Ill.
- G. Desgouttes, Nice, France.
- Dr. Antonio Milone, Catania, Italy.
- Warren J. Dougherty, Kincaid, Kan.
- Wm. J. Haavisto, Ilwaco, Wash.
- Harlan Hodke, Ashland, Ky.
- Jack W. Lee, Oatman, Ariz.
- B. H. Swaney, Erie, Pa.
- Armando Patriarca, Rosario, Rep. Argentina, So. America.

Frank L. Dodd, Lewisburg, Pa.  
Glenn E. Warren, North Hollywood, Calif.  
Kermit R. Kruger, Hartford, Conn.  
W. Pickering, Vancouver, British Columbia.  
In conclusion, *Radio-Craft* extends a special vote of thanks to Director Jack Grand; to the Judges who so freely and cheerfully devoted many valuable hours in careful consideration of every single entry in this contest; to the publications which so kindly gave space to mention of this contest; and to the manufacturers whose gratuitous donations of valuable service instruments made this contest so successful.

**THE LATEST RADIO EQUIPMENT**

(Continued from page 351)

V.C., shadow tuning, and many other advanced features. Dial is of the full-vision airplane type, with dual-ratio control. The metal tubes used are: 2-6K7s, 1-6A8, 2-6H6s, 1-6C5, 1-6F6, and 1-5Z4.

**A.C.-D.C. NOISE FILTER (872)**

THIS device is not to be connected to a radio set but is designed to work at the point of noise regeneration, such as at a motor or other electrical device. Only a few sizes of the apparatus are needed for all applications, the only difference in the models being in the current-carrying capacity. May be used on 6 to 200 V., A.C.-D.C. There are no variable controls.



Left, new set. (871) Below, noise filter. (872)



**“Your Book Makes The Tough Jobs Easy!”**



**FREE!**  
**Send for Your Copy Today**

● SERVICE MEN everywhere praise Sylvania's new book, *Service Hints* . . . Send for your FREE copy today . . .

Sylvania's book, *Service Hints*, contains a world of practical servicing tips compiled by hundreds of successful service men from all over the country. It gives you the simple solutions to everyday service problems with special attention given to the hard-to-crack jobs. You will know that you are getting first-hand information because it has been gathered through actual experiences. These valuable tips may save you hours of trouble-shooting on some tough problem.

Don't wait! Send for your copy of this valuable book today. Get the inside dope on receiver troubles. Iron out your problems. Put yourself in a position for more and better service jobs with bigger profits. There's no charge at all. Just fill out the coupon below, today, and you will receive your copy of *Service Hints*, Volume 2, in a few days.

Hygrade Sylvania Corporation. Makers of Sylvania Radio Tubes and Hygrade Lamps. Factories at Emporium, Pa., Salem, Mass. and St. Mary's, Pa.

© Hygrade Sylvania Corp., 1935  
**SYLVANIA**  
THE SET-TESTED RADIO TUBE

**Hygrade Sylvania Corporation Emporium, Pa.** RC-12

Please send me free, without obligation, Volume 2 of Sylvania's "Service Hints."

Experimenter  Amateur  Call.....  
Serviceman  Employed by dealer   
Independent

Member Service Organization .....

NAME .....

ADDRESS .....

CITY .....

STATE .....

NAME OF JOBBER .....

ADDRESS .....

Please Say That You Saw It in RADIO-CRAFT



## COMBINATION WOOD and METAL CUTTING LATHE



Only \$7.95 (Less Chuck)

\$3.50 extra for chuck (4 jawed, 3 in.)

Bushing to Fit Chuck to Lathe 50c  
65c extra for 5" woodworking "T" rest  
LENGTH: 20 in.  
WIDTH OF BASE: 4 in.  
HEIGHT OVERALL: 9 in.  
WEIGHT: 21 lbs.  
SPEED: Two-step pulley.  
FINISH: Baked on GRAY ENAMEL.  
COMPLETE with Compound Slide rest.

Slide rest having Swivel base and tool holder. Large oversized bronze bearing. Accurately planed bed, machined face plate. Hollow Spindle, 5 in. swing. Standard Morse tapers; 13 in. between centers. Shipping weight: 26 lbs.  
Send \$2 deposit balance C.O.D. Sold on money-back guarantee basis.

**Wellworth Trading Company**  
Dept. RC-1235  
560 West Washington Boulevard, Chicago, Illinois

## FREE Bargain Bulletin

**PRICE SLASHED!** **6.00**

**COMPACT A. C. - D. C. RECEIVER**

**12.50**

**2.95**

**11.47**

**RADIO TRADING CO.**  
Hudson St., New York City

Contains new metal-tube receivers; complete public address systems from 6-watts to 40-watts at unbeatable prices; testing apparatus; famous Doerle short-wave receivers, etc., etc. Read about our unparalleled 5c sale on 41 ARANTEED tubes.

Our low prices save you money. DON'T DELAY! WRITE TO-DAY. Send postcard or letter. Bulletin by return mail. IT'S FREE!

**RADIO TRADING COMPANY**  
97 Hudson Street, New York, N. Y.

## The Raco 339 All-Wave Direct Reading Signal Generator



(55-17000 K.C. on fundamentals.) 1% accuracy on all bands 54-17000 K.C. all on fundamentals. Dial calibrated in both meters and kilocycles modulated or unmodulated at will by means of on-off switch. Attention control—Universal operation (A.C.—D.C.) Electron coupled Generation. The 339 has a 6C6 R.F. oscillator, a 27 rectifier tube, so that D.C. is used on the plate, while modulation is provided by a neon tube relaxation oscillator at a frequency of about 1000 cycles. Wired, tested, calibrated, with 3 tubes (6C6, 27, neon), \$16.00 net in Series form.

**RACO** RADIO CONSTRUCTORS LABORATORIES  
136 Liberty St., N. Y. C., N. Y. Dept. RC3

## RADIO At Its Best

(1)—Write for FREE NEW CATALOG of Condensers, Transformers, Chokes, Sockets and general equipment for receiving and transmitting.  
(2)—SEND 10c for New 32-page Manual of most popular Short-Wave Receivers, with illustrations, diagrams and parts lists.

Address Dept. RC-12  
HAMMARLUND MANUFACTURING CO.  
424-438 W. 33rd St., New York



## HOW TO MAKE A SENSITIVE RELAY UNIT

(Continued from page 346)

bumpers are removed from the dial face allowing the dial to be lifted from the meter. Use extreme care in these operations as the meter is a delicate instrument.

New leads are now placed between the binding posts and the moving coil and the "works" replaced in the case and secured there, omitting the resistance coil.

The lead from the front spring is grounded and connects also to the vane, therefore this lead will constitute one of the contact-point connections, and the binding post should be so marked. This will avoid mistake, such as passing the contact current through the moving coil.

The details of the mercury cup are shown in Fig. 1. The cup is nothing more than a cap from a screen-grid tube, about one-fourth its length being ground off so as to fit in the opening at the center of the meter. The cap is soldered to the end of a threaded rod or bolt, the bolt being flattened to one-half its diameter at the junction. It will also be necessary to enlarge the hole in the bakelite case through which the bolt is to pass (that is, the one formerly used for securing the resistance coil).

The vane is bent about half-way out and at right-angles to itself so as to pass the point into the mercury cup when current turns the moving coil. Although the meter may have been calibrated for over 100 V. with the resistance coil in the circuit it will now require less than 1 V. to pull the vane into the cup, so care must be exercised to protect the fine winding of the moving coil. In using a single flashlight cell, use a 2,000 ohm variable resistor, R, in series.

With the cup  $\frac{3}{4}$ -full of mercury and the vane set for zero, the point of the vane should be just slightly above the level of the mercury. The zero adjuster on the glass cover constitutes the final adjustment of the vane contact.

This completes the construction details of the sensitive or "primary" relay. With proper adjustment it will operate on 500 microamperes and with a speed of several times a second. Because of the low pressure on the vane with small currents through the meter, it is desirable to use a secondary relay for handling larger currents than the light contact at the vane will permit.

### THE "SECONDARY" RELAY

Again we resort to the junk-box and emerge with another obsolete part which may be found in almost any radio man's shop—a Philco "A" and "B" eliminator remote control or automatic relay. (See Fig. 2.) Remove this unit from the eliminator, if so attached, by loosening the two retaining nuts and removing the wire leads. The elevated stationary contact is removed and the hole at its base used in mounting the relay. The outer contact arm on the armature is also removed, being only an unnecessary weight in this instance. Rewind the coil to a resistance of 2,000 to 6,000 ohms and replace. Solder leads to the required lugs and mount this relay as well as the sensitive relay on a convenient panel, making the proper connections between them as per Fig. 2.

Shunts across the meter relay allow it to be used with larger currents on the input circuit. A "current-bucking" circuit may also be used to advantage in many instances. (See "20 Ways to Use the 'Electric Eye,'" Fig. 14, pg. 588, April, 1935 Radio-Craft.—Editor)

## OPERATING NOTES

(Continued from page 354)

### RK MODEL S5 RADIOSET

THIS set was brought in because of low volume, distortion and hum. This is an A.C.-D.C. set. The condenser across the bias resistor of the 43 tube was found to be defective, and was replaced, and the set realigned. Operation was then fair, except that there was a hum evident, unless the plug was inserted in the line outlet in one particular way.

The trouble was then found to be a high-resistance grid lead. The connection of the wire to the grid clip of the 77 tube was improperly soldered. The fault was remedied, and the set then worked well with the plug inserted in the outlet in either direction.

This trouble and remedy would seem applicable to other universal or A.C.-D.C. radio sets.  
MALCOLM A. PECKHAM

# PARADE

CLOUGH-BRENGLE 1936 Models



- 1—MODEL 82 Direct Reading Oscillator—85 k.c. to 21 m.c.  $\frac{8\frac{1}{2}}{1\%}$  scale, Net \$19.90
- 2—MODEL OC R.F. Oscillator—with direct reading chart, Accuracy of  $\frac{1}{2}$  of 1%, Net \$32.90
- 3—MODEL 81 Modulator, Fixed sweep type to use with any oscillator, Net \$34.25
- 4—MODEL 79 Audio Oscillator, 50 to 10,000 cycles A.C. operated, Net \$51.90
- 5—MODEL OM Oscillator, with built-in frequency modulator for use with any Cathode-ray oscilloscope, Net \$57.85
- 6—MODEL CRA Oscilloscope, complete with Cathode-ray tube, Net \$84.50

Write for FREE Catalog describing these and the many other C-B instruments

The Clough-Brengle Co.  
1130 W. Austin Ave., Chicago, U.S.A.

Send us complete literature on the new 1936 C-B line of Professional Instruments.

Name .....

Address .....

City..... State.....

My Jobber is.....

# EBY Announces

## TYPE 12-E METAL TUBE SOCKET



A new 8-prong moulded Bakelite Universal Socket for all Octal metal shield tubes. New double action phosphor bronze springs.

## TYPE 8-E SUB-PANEL MOUNTING



Similar to 12-E but designed with laminated Bakelite base for convenient sub-panel mounting.

EBY Quality Radio Products are sold by leading jobbers. Write for catalog of service, amateur and experimental parts including.

- BINDING POSTS
- AC SWITCHES
- SHORT WAVE SWITCHES
- TIP JACKS
- TAP SWITCHES
- MALE & FEMALE PLUGS ETC.

**HUGH H. EBY Inc.**  
2066 Hunting Park Ave.  
PHILADELPHIA, PENNA.

## NOW! H. G. Cisin's TWO METAL TUBE ALL ELECTRIC AIR SCOUT



Only Set of its kind in the world

Pat. Pending U.S. Serial No. 592,586. Operates on A.C. or D.C. Self-Contained Power Supply.

Near View Showing New Metal Tubes

**POWERFUL**—Many Air Scout owners report reception from England, Germany, Spain, Rome and other foreign stations. Wonderful short wave reception. Broadest reception on indoor aerial. Pulls calls, code, procedure and Trans-Atlantic phone conversations. **NEW METAL TUBES**—GREATER EFFICIENCY. Four plus-in coils cover 10 to 200 meters. Extra coils for Broadcast Reception, also special Long Wave unit. Operates several broadcast stations simultaneously. Sleaker on other stations. **Complete, Assembled Kit, with instructions and picture diagram, and all four short wave coils, without tubes, \$3.95 ready to wire.**

Set of 2 Matched Metal Tubes	\$2.50	Broadcast Coils (Two)	\$1.45
Special Long Wave Unit w. Coil	.95	Earphone (Single)	\$.60
		Total	\$9.35

**Special Combination Offer—Assembled Kit, not wired, 2 metal tubes, 7 coils including Long Wave Unit, \$8.40 earphone**  
Above Custom-Built, Wired and Laboratory Tested, ready to use \$1.00 extra.

H. G. CISIN, Chief Engineer, Allied Engineering Institute  
Dept. S-22 58 Park Place, New York, N. Y.

Become a Radio Expert

## GOOD JOBS Learn RADIO-TELEVISION

Electricity—Talking Pictures—in Los Angeles  
Learn profitable trades by practical shop methods. Enroll with National, oldest, largest trade school in the West. 30,000 graduates. Qualify as a radio repair man; television expert; sound expert; broadcast station technician; electrician and for many other jobs. Earn room and board while learning. Highest opportunity for you. Far limited time we will allow each railroad fare to Los Angeles. Send for free book which gives full details about different jobs you can qualify for, complete course of instruction and photographs of school operations. Sign and mail coupon.

**NATIONAL SCHOOLS.**  
Dept. 12-RC, 4000 So. Figueroa St., Los Angeles, Calif.  
Please send me your Big Free Book on Television, Talking Pictures, Radio and Electricity. Also details of R. R. fare offer.

Name.....  
Address.....  
City..... State.....

### STOP GUESSING! WHAT IS WRONG WHAT TO CHARGE

Radio service is easy when you know just where to look for the troubles. Progressive Servicemen everywhere use a CHUCKER trouble-graph and repair-price! 50c postpaid. (No Stamps.)  
**PAUL G. FREED (Publishing Division R)**  
5053 Baltimore Ave. Philadelphia, Pa.

## THE PE. CELL IN THE EXPERIMENTER'S LAB.

(Continued from page 344)

the first tube, as shown. The condition as now set up is two stages of direct coupling.

Very minute changes in the light intensity falling on either of the cells shown, will result in large changes in the plate current of the second tube. As far as the action is concerned the output of the second tube will be exactly the same as the output of a 1-tube amplifier, except that it will have this added sensitivity.

If applied to a color matching device, this hookup is capable of detecting differences in color or in light intensity, which are far beyond detection by the human eye. It is important that a separate voltage supply be provided for the two filaments, otherwise a leakage will occur between cathode and filament which can cause breakdown in the tube.

### NEON-TUBE CONTROL

Figure 1D illustrates a useful hookup in which a neon tube is involved. The cell shown is connected in series with a source of supply and a condenser, which may be of any value depending on the speed of operation desired.

As the condenser in the circuit receives its charge, the potential across its dielectric increases until it reaches the spill-over voltage of the neon tube. At this instant current passes through the tube, thus energizing the relay which is connected in series with it and, at the same time, discharging the condenser, thus causing the cycle to repeat.

The speed with which this pulsation takes place is dependent on the capacity of the condenser, which value may range from .005-mf. to 1., or more, mf.; it is also dependent on the resistance of the cell. The intensity of the light striking the cell may, therefore, be measured by the speed of pulsation of the neon tube and relay.

If the cell is not subjected to a continuous light intensity, but rather to various frequencies (even constantly changing frequencies), the device serves as an "integrator," thus adding up, say, a large number of small flickers of light on the cell or a few large flickers; or even a combination of the two. The conditions may be made such that several pulsations will take place on a single brilliant flicker, while any number of small flickers may be required to cause the same spill-over.

If the condenser value in this circuit is small, its ability to store current is likewise small and it may not be capable of operating a heavy relay.

### AMPLIFYING MOTION

Figure 1E illustrates a method by which very small motions of a spot of light can be translated into mechanical motion. In this figure, M is a triangular mirror, such as the surface of a prism, having two sides "S," which are silvered. Light coming from any remote source is collected by the astigmatized lens and brought to a focus in a line, rather than at a point as in the case of the ordinary lens. Two cells, A and B, face the silvered surface of the prism, such that they receive any reflected light, as from the source. If the focused line of light falls directly on the points of the prism, the energy will be reflected on either side with equal intensity, thus energizing both cells equally. If this line moves either to the right or left even the most infinitesimal amount there is a differential between the light intensity as received by the two cells.

If they are employed in a circuit (such as that of Fig. 1C), and the circuit is balanced when this line falls exactly on the point of the prism, then any motion of the line away from dead-center will result in an unbalance in the circuit, and an indication of the direction of unbalance.

Providing the cells and the mirror are mounted on the same movable base this combination can be made to follow the motion of the line by having the circuit control motors or other devices to affect this motion. This illustration applies to constructions in either a horizontal or vertical plane.

It is by such a system that mechanical robots follow the direction of a flash-light beam or that the astronomer mechanically follows the sun or other heavenly bodies.

## IMPULSE CIRCUITS FOR AUTOMATIC CONTROL

Figure 1F illustrates two simple impulse circuits connected in push-pull fashion, both operating the same relay. The fulcrum of the relay armature is at the center rather than at the conventional end. A magnetic coil in each circuit exerts attraction on opposite ends of the armature.

With the construction shown, both coils are continually energized unless there is an instantaneous change in the light flux on either cell. With a change in flux, one or the other coils will release, providing both cells are not simultaneously affected. Since both are energized, the armature will remain against that coil to which it is nearest.

This principle is often applied in instruments, the motion of the indicating needle intercepting the light striking the cells as it moves from low to high, or vice versa. If the apparatus is arranged to control whatever the needle is giving indication of, then an automatic control between the limits as determined by the spacing of the cells, is gained.

(Credit is hereby given to the General Electric Company, and Hugh H. Eby Inc., for supplying some of the material used in this article.—Editor)

## STATEMENT OF THE OWNERSHIP, MANAGEMENT, CIRCULATION, ETC., REQUIRED BY THE ACT OF CONGRESS OF AUGUST 24, 1912.

Of RADIO-CRAFT, published monthly at Mount Morris, Ill. for October 1, 1935. State of New York } ss. County of New York }

Before me, a Notary Public in and for the state and county aforesaid, personally appeared Irving S. Manheimer, who, having been duly sworn according to law, deposes and says that he is the business manager of Radio-Craft and that the following is, to the best of his knowledge and belief, a true statement of the ownership, management (and if a daily paper, the circulation), etc., of the aforesaid publication for the date shown in the above caption, required by the Act of August 24, 1912, embodied in section 411, Postal Laws and Regulations, printed on the reverse of this form, to-wit:

1. That the names and addresses of the publisher, editor, managing editor, and business managers are: Publisher, Continental Publications, Inc., 404 N. Wesley Ave., Mount Morris, Ill; Editor, Hugo Gernsback, 99 Hudson Street, New York, N.Y.; Managing Editor, R. D. Washburne, 99 Hudson Street, New York, N.Y.; Business Manager, Irving S. Manheimer, 99 Hudson Street, New York, N.Y.

2. That the owner is: (If owned by a corporation, its name and address must be stated and also immediately thereunder the names and addresses of stockholders owning or holding one per cent or more of total amount of stock. If not owned by a corporation, the names and addresses of the individual owners must be given. If owned by a firm company, or other unincorporated concern, its name and address, as well as those of each individual member, must be given.) Continental Publications, Inc., 99 Hudson Street, New York, N.Y., that all the stock of Continental Publications, Inc., is owned by Gernsback Publications, Inc., 99 Hudson Street, New York, N.Y., and that stockholders of Gernsback Publications, Inc., owning more than 1 per cent of the stock are Hugo Gernsback, 99 Hudson Street, New York, N.Y., Irving S. Manheimer, 99 Hudson Street, New York, N.Y.

3. That the known bondholders, mortgagees, and other security holders owning or holding 1 per cent or more of total amount of bonds, mortgages, or other securities are: (If there are none, so state.) None.

4. That the two paragraphs next above, giving the names of the owners, stockholders, and security holders, if any, contain not only the list of stockholders and security holders as they appear upon the books of the company, but also, in cases where the stockholder or security holder appears upon the books of the company as trustee or in any other fiduciary relation, the name of the person or corporation for whom such trustee is acting, is given; also that the said two paragraphs contain statements embracing affiant's full knowledge and belief as to the circumstances and conditions under which stockholders and security holders who do not appear on the books of the company as trustees, hold stock and securities in a capacity other than that of a bona fide owner; and this affiant has no reason to believe that any other person, association, or corporation has any interest direct or indirect in said stock, bonds, or other securities than as so stated by him.

IRVING S. MANHEIMER, Business manager.  
Sworn to and subscribed before me this 24th day of September, 1935.  
(Seal.)

MAURICE COYNE.  
(My commission expires March 30, 1936.)

Please Say That You Saw It in RADIO-CRAFT

# Westinghouse Power Generator

Manufactured for U. S. Signal Corps  
200 Watt. 110 V. AC



## A. C. ELECTRICAL POWER

from a Windmill, from available Waterpower, from your Automobile, from your Motorcycle, from your Bicycle, Foot-pedal or Handcrank (for transportable Radio Transmitters, Strong Floodlights, Advertising Signs); do you want to operate AC Radio sets from 25 V. to 110 V. AC? obtain two generators in series to get 200 V. AC; obtain two phase and three phase AC, etc., etc.

### There Are Over 25 Applications

Some of which are:

A.C. Dynamo lighting from eight to ten 20 Watt 110 Volt lamps, Short Wave Transmitter supplying 110 Volts AC for operating "Ham" transmitter, Operating 110 V. AC 60 Cycle Radio Receiver in DC districts, Motor Generator, Public Address Systems, Electric Sirens on motor boats, yachts, etc., Camp Lighting, Short Wave artificial "fever" apparatus, Television, Pelton Waterwheel for lighting or other purposes, Airplane for lighting strong search lights or electric signs, Laboratory work, etc., etc. 1/4 to 1/2 H.P. needed to run generator.

BLUE-PRINT 22 x 28 in. and Four-Page 8 1/2 x 12 in. INSTRUCTION SHEETS FREE.

Generator, as described, including four replacement carbon brushes. Blue-print and \$7.90 instructions

Send \$2.00 deposit balance C.O.D. Shipping weight 18 lbs.

(Replacement carbon brushes bought separate \$1.50 per set of four. Set of instructions bought separate \$1.00.)

MONEY-BACK GUARANTEE.

## WELLWORTH TRADING COMPANY

560 West Washington Blvd., Dept. RC-1235, Chicago, Ill.

# tests both ALL-METAL and GLASS TUBES

Plugs into 110 Volt AC Line



## Combined TUBE and SET TESTER

Tests every type of receiving tube made including all-metal and glass types. Uses 5" fan-type meter with English reading "Good-Bad" scale. Tests shorts and leakage with neon light. Makes continuity and ohmmeter tests. Tests paper and electrolytic condensers. Simple to operate—no adapters required. Separate line voltage meter. Counter model. Ship. wt., 10 lbs.

No. 305KC Tube Checker Kit \$17.86 YOUR PRICE  
No. 305C Tube Checker, completely wired \$21.96 and tested. YOUR PRICE.

## Radio Trading Co.

97 Hudson St., New York, N. Y.

# BE "FROM MISSOURI"

Below is the contents of the second full page ad. in the *New York Times* in which Philco accuses G.E. of taking advantage of the radio public. Further information will be found on page 326 of this issue.

### BE "FROM MISSOURI"

"Proven worth is preferable to risky experiment!" Ten years ago, in the early days of radio, there may have been some excuse for the radio industry to conduct experiments outside the laboratory . . . for asking the public to assume the expense of testing new radios, new tubes, new circuits. For one thing, adequate laboratory facilities for testing and sorting-out innovations had hardly been created.

Today there is no excuse for the radio industry to experiment on the public, and at the public's expense, Philco, with its great Research and Engineering Laboratories, like those of the great motor car manufacturers, is definitely committed to lifting this load from the public.

Philco experimentation is confined in the Philco Research Laboratories. New features constantly appear in Philco radios, but every new Philco feature must have real scientific merit, proven in the Philco Laboratories at Philco's expense, and must add definitely to performance and reliability.

The 1935-1936 line of Philco radios is entirely equipped with glass tubes for the very simple reason that metal tubes are still in an experimental stage, and that glass radio tubes are of the highest radio performance value today.

### Philco Uses Glass Tubes Because:

1. Highly perfected high efficiency tubes are available in every conceivable single and multiple function type. Using these tried and proven tubes, Philco receivers give better performance than can be obtained with a greater number of metal tubes.
2. With the wider choice provided in glass tubes, a much greater output of pure tone may be enjoyed than with metal tubes.
3. Glass tubes have proved their ruggedness. They are universally shipped installed in sockets ready for use. And millions of radios using glass tubes are in daily use in automobiles driven at all speeds over all kinds of roads.
4. Loss of vacuum is practically unknown in glass tubes.
5. In short-wave foreign reception the prime requisites are good dielectric properties and good insulation. Glass is inherently a good dielectric and good insulator. Glass tubes give better short-wave foreign reception.

### Philco Does Not Use Metal Tubes Because:

1. In metal tubes, tube size is reduced. With the same amount of heat to dissipate, the smaller metal tubes operate at a higher temperature.
2. This higher temperature tends to shorten tube life. It also changes the characteristics of nearby coils, resistors, etc., which impairs the delicate balance of all the various parts . . . a balance that is essential for the performance.
3. Many highly desirable multiple function tubes . . . now in general use . . . are not available in metal.
4. More metal tubes than glass are required. Metal tubes are high in price. Metal tube sets cost more money and deliver less performance. And the replacement cost of a set of metal tubes is approximately double that of glass.
5. The inability to see inside a metal tube is a real disadvantage. The transparency of glass often allows the user, the service man and the factory inspector to determine when a tube is not functioning.
6. Loss of vacuum is a serious hazard in metal tubes. An air leak at any point . . . and there are over twice as many points to seal in metal tubes . . . stops a radio from working.
7. At first glance, and until one remembers the proven ruggedness, power, tone, dependability and long life of glass tubes, metal tubes may make a superficial sales appeal. However, Philco never has and never will adopt any innovation merely for "sales ballyhoo" appeal.

If Philco were making bread, Philco could legitimately offer the public both wheat bread and rye bread—one as high in quality as the other. Part of the public would get greater satisfaction from wheat bread. Another part would find rye bread more to its taste.

But Philco cannot legitimately offer the public both glass and metal tubes. The metal tube is not as high in quality as the glass tube.

In the delicate scientific radio mechanism, the public is not in a position to decide which is better. The Philco Engineering and Research Laboratories, with their trained engineering staff and extensive and costly testing apparatus, must make such decisions for the public and select for Philco radios all parts best suited to produce maximum performance.

Performance is what counts. It is of no importance to Philco—not to the public—whether tubes are made of glass, metal, wood or porcelain, so long as they do their full share to enable the radio as a whole to give maximum performance.

Philco has experimented with, tested and retested metal tubes. They have been "weighed in the balance and found wanting." Their performance is inferior to glass, their cost is higher, their reliability in service is less. So Philco uses glass.

### "Proven worth is preferable to risky experiment!"

This basic Philco policy may not be spectacular, but it protects Philco buyers, and the American public has approved it in no uncertain terms—

1. They have bought more Philcos than any other make for the past six years.
2. They have bought over 6,000,000 Philcos.
3. At the present time they are buying more Philcos than ever before. Factory employment is 10% above employment a year ago—over 10,000 workers at the highest wages in the industry.

### Philco Guarantees Greater Performance

(Tube for tube. . . . And even more!)

Philco radios with glass tubes are guaranteed to—

1. Outperform radios with the same number of metal tubes.
2. Outperform radios with one to three additional metal tubes.
3. Outperform radios with metal tubes which cost much more money.

This guarantee covers both power and tonal quality . . . on both American and Foreign reception.

In addition to glass tubes, Philco radios give you many other Philco features which will multiply your radio enjoyment year after year and which make Philco truly A Musical Instrument of Quality.

The public is entitled to know the facts; therefore these facts and conclusions are presented by Philco Radio & Television Corporation.

# Today's MOST Distinguished Radio Achievement



## CUSTOM BUILT ROYALE 24-TUBE Radio

THIS super radio-musical instrument was created for those discriminating and exacting few who insist on the finest, most beautiful, most precisely built radio obtainable. A set of rare distinction, musically and artistically perfect, the Royale offers over 100 features . . . assuring a luxurious and idealized type of brilliant, sparkling, guaranteed world-wide performance . . . heretofore unattainable. It is today's only "aged" radio . . . offers 6 tuning ranges . . . 4 1/2 to 2400 meters . . . etc.

This 24-tube achievement outperforms other receivers. Assures Unlimited Scope Full Fidelity Audio range is 20 to 16,000 cycles per second . . . 40 watts undistorted output. Fully guaranteed for 5 years . . . absolute satisfaction assured

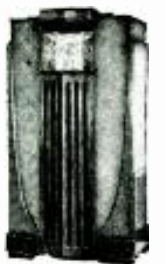

The 30-day FREE Trial Offer enables you to try the Royale in your own home, without obligation. Write for literature now or mail coupon TODAY.

ROYALE RADIO CRAFTERS (Division Midwest Radio Corporation) Dept. 206F, Cincinnati, Ohio.

Without obligation, send me literature describing Custom-Built 24-Tube 6-Tuning Range, Royale Radio . . . and details of your 30-day Free Trial Plan.

Name: \_\_\_\_\_  
Street: \_\_\_\_\_  
Town: \_\_\_\_\_ State: \_\_\_\_\_

QUALITY recommends

# Condensers by SOLAR

WET . . . DRY PAPER MICA . . . THINNER



SOLAR MFG. CORP. 593-501 Broadway New York City

Please Say That You Saw It in RADIO-CRAFT

## PEAK Regenerative Pre-Selector

Are you satisfied with your S. W. reception?

The Peak Pre-selector P-11 used and acclaimed (ask "em") by thousands of amateurs and DX'ers. The only commercial Pre-selector available that absolutely guarantees satisfaction. As W2HFS said yesterday, "The Pre-selector that makes a good set infinitely better." Enjoy SW reception!! Get a Peak Pre-selector.

Tremendous increase in signal strength—increase in sensitivity and selectivity—absolute rejection of image—decrease in noise to signal ratio.

Type P-11 Your cost \$19.00 less tubes. Dimensions 7/4"x9/4"x10"

**PEAK Q-5**—The last word in design of Ultra-High Frequency Super Het Receivers.

Dimensions 10" deep, 7" wide, 8" high. Your cost \$21.60.

**PEAK X-4**—10 watt 5 meter x-mitter. A moderately priced ultra-modern high frequency transmitter. Class B<sub>1</sub> modulator, 100% modulation. 6.46 unity coupled oscillator with adjustable clips for antenna coupling.

Standard rack size 8 3/4" x 19". Your cost \$29.70.



You can't go wrong when you buy Peak apparatus. All Peak Products unconditionally guaranteed to give absolute satisfaction.

**Eastern Radio Specialty Co., Inc.**  
Mfrs. of PEAK PRODUCTS  
1845 Broadway New York City

## SHORT-CUTS IN RADIO

(Continued from page 349)

### HONORABLE MENTION

**METER REPAIR.** While using my ohm meter in a hurry, I accidentally touched the prods to high voltage and made an "S" out of the pointer! It was of the knife-edge type, and while trying to straighten it out, 1/2-in. broke off. Since the pointer was hollow, I carefully opened the end with a needle. Then a piece of stiff hair was dipped into a thin solution of speaker cement and stuck into the opened end of the pointer. When dry the hair was cut to the proper length, and the repaired indicator rebalanced with the three weights. This repair is very light and allows the needle to act perfectly. See Fig. 8.

F. H. RAST

### HONORABLE MENTION

**SOLDERING IRON HOLDER.** This kink will save space in the tool kit. The holders are bent from 1/16- to 1/8-in. wire. They must be strong enough to hold the iron securely, yet must dissipate sufficient heat. The holder hangs on the edge of the tool box when in use. See Fig. 9.

ED DYKE

### HONORABLE MENTION

**MULTIPLE-USE METER.** Experimenters often need several expensive milliammeters, of the same rating, for use in different pieces of equipment. This short-cut enables one meter to be used in any number of different units. It is simply necessary to fasten a tube base to the rear of the individual meter, and connect the binding posts to two base prongs. A socket to fit is installed on each piece of equipment and the money saving scheme is complete. See Fig. 10.

JOHN OBERITTER

### HONORABLE MENTION

**RESISTOR HOLDER.** Don't laugh! this idea is a real time saver. The holder is made from a board 1 in. thick, with other dimensions according to the number of resistors to be held. The holes are drilled at an angle in order to keep the resistors from dropping out. As shown in Fig. 11, the holes may be marked according to the values on the board.

H. E. BECKER

### HONORABLE MENTION

**CHASSIS HOLDER.** After trying many and fearsome devices to hold a chassis, I hit upon this simple solution. All the details for construction of this handy apparatus are shown in Fig. 12.

E. KINGERY

### HONORABLE MENTION

**REPLACING GRID CAPS.** These caps are often pulled off good tubes, but the tube may easily be made usable again, if the wire lead is still intact. Place the cap in position on the tube and put a bit of soldering paste on top of the cap. Hold the tube at an angle of 45 degrees, and allow the flame of a torch to heat the lower part of the cap until the wax melts. By this time the solder on the cap will have melted, and the paste will insure a good connection. After cooling, the cap will be found to be as firm as ever. See Fig. 13.

W. FARMER

### AMPERITE HIGH LEVEL VELOCITY

Operates WITHOUT PRE-AMP  
HIGH IMPEDANCE—2000 OHMS

THIS MICROPHONE IS HIGH ENOUGH IN IMPEDANCE TO OPERATE DIRECTLY INTO GRID . . . BUT NOT HIGH ENOUGH (ONLY 2000 OHMS) TO INTRODUCE SERIOUS LOSSES IN LINE UP TO 200'.

Replaces condenser and crystal mikes. No changes necessary. Eliminates input transformer and its losses. Eliminates hum trouble and feedback.

**ELIMINATES HUM TROUBLE**

MODEL RB-H. for speech and music. LIST \$42.00 with coupling. MODEL RS-H. for speech, but can also be used for music. LIST \$32.00 with coupling. Write for Bulletin H.

**NEW! POSITIVE AND SMOOTH-ACTION STANDS**

Positive, non-sliding, ball-bearing clutch. Will never wear out . . . never require adjustment. WILL NOT "CREEP". Tightens with only 1/4 turn of clutch. Mike can be rotated without loosening clutch. SMOOTH, PNEUMATIC. LIKE ACTION up and down. A model for every purpose. WRITE FOR ILLUSTRATED BULLETIN S.

AMPERITE COMPANY 561 BROADWAY NEW YORK

AMPERITE HIGH LEVEL VELOCITY MICROPHONE

## HOW THE 6E5 CATHODE-RAY TUNING TUBE WORKS

(Continued from page 348)

in and out of resonance, this "eye" is caused to wink, or better "close (or open) the pattern" appearing on its glass top. Since the tube is mounted in the cabinet with its top facing the observer, the patterns would look something like those of Fig. A.

Let's go back to the schematic of Fig. 1 and find out the reasons for this action, starting first at the triode-section of the 6E5. We see that the detected signal voltage is applied to the control-grid of the triode section of the 6E5 from point A of the diode-detector circuit. In tuning in a station (as one turns the dial slowly) triode-grid TG becomes more negative with respect to the cathode, K. This means that the plate current is decreased so that a decreased voltage will exist across the 1 meg. plate resistor, R. When the station is tuned exactly to resonance the detected signal fed to grid TG of the 6E5 is such as to reduce the plate current practically to zero. Note that the ray-control electrode, E, is connected directly to triode plate T, and varies with the positive voltage on the plate so that as the signal is tuned in and the drop across R decreases, the voltage on E increases—being a maximum at resonance. As one tunes off resonance the decreased negative voltage at A causes a decreasing triode grid bias and therefore an increasing triode plate current. This increasing plate current in turn causes an increasing voltage drop in R, thus lowering the positive potential of the ray-control electrode.

### CONTROLLING THE PATTERN

It is the variation of the voltage thus obtained on the ray-control electrode which controls the displacement of electrons and causes the "eye" to close as the station is tuned-in; and to open as the station is tuned-out. The way in which the voltage of the ray-control electrode governs the displacement of electrons is shown in Fig. 2, at A, B and C.

In Fig. 2A T represents the target and k the ray-generating portion of the cathode. (In this figure it is assumed that the ray-control electrode is not present.) Since the target is always at a positive supply voltage of 250, we can represent the electric field by lines of equi-potential as indicated. That is, because of the symmetry of the figure, all points a given distance away from the por-

(Continued on page 380)

The shadow effect on the target is illustrated by these three sketches.

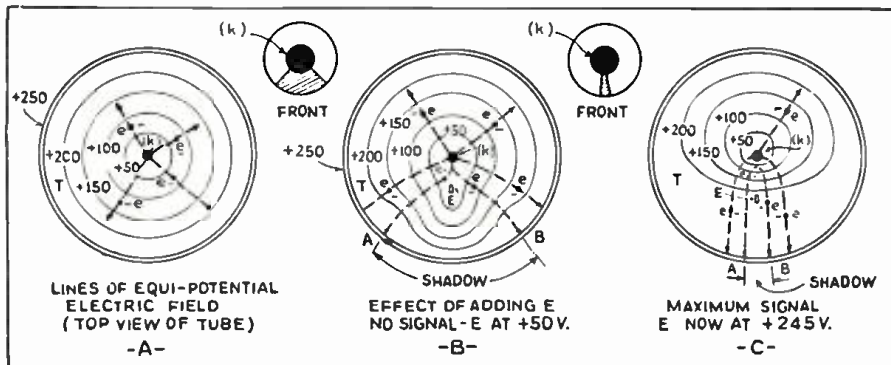

Please Say That You Saw It in RADIO-CRAFT

## The New AUTONATOR

delivers 110 VOLTS A.C. IN CARS AND TRUCKS

The new AUTONATOR generates 110 Volt A.C. Current in motor cars, aeroplanes and from all types of engines and motors, direct from fan belt. Costs nothing to operate. No service—no brushes, collector rings, commutator or wire wound armature. Ideal for operating PORTABLE Sound equipment, A.C. Radio Sets, Neon Signs, Electric Lights, searchlights. Send for complete details.

**AUTONATOR LABORATORIES, Inc.**  
8440 South Chicago Avenue, Dept. RC, Chicago, Illinois

## RADIO

biggest opportunities still ahead

ALMOST in a decade radio has become a giant industry. The opportunities created will be enjoyed by trained men. The International Correspondence Schools Radio Course, prepared by leading authorities and constantly revised, will make you a trained man! A fascinating book—free.

**INTERNATIONAL CORRESPONDENCE SCHOOLS**  
Box 6678-B, Scranton, Penna.

Send me—free—Information on subject checked:

Radio  Radio Service Man  
 Radio Operator  Electrical Engineer

Name.....  
Address.....

# TYPEWRITER BARGAIN

10-DAY FREE TRIAL OFFER

FREE HOME TYPING COURSE



ONLY 10¢ A DAY

**BRAND NEW MODEL No. 5 REMINGTON PORTABLE**

● A brand new Remington for only 10c a day. An easy, practical Home Typing Course FREE. With it anyone quickly becomes expert on this machine...the most rugged, dependable portable made. Not used or rebuilt. Standard 4-row keyboard. Standard width carriage. Margin release on keyboard. Back spacer. Automatic ribbon reverse. *Every essential feature of big office typewriters.* Carrying Case FREE. Try it for 10 days without risking a cent. If you don't agree it is the finest portable at any price, return it at our expense. Don't delay. Without obligation, write now. Remington Rand Inc., Dept. 189-12 205 East 42nd Street, New York, N.Y.

## HANDY Electric PAINT SPRAYER

ONLY \$14.50

Complete Outfit and Spray Gun



Startling offer! Famous spraying outfit includes pressure internal mix spray gun, adjustable, non-clogging, fan and round spray nozzles. Ideal for spraying paint, varnish, enamel, lacquer, shoe dyes, aluminum paints, insecticides, etc. The power may save time and labor and does better work. Outfit complete with spray gun, National Compressor with sealed piston (cannot pump oil), heavy duty Westinghouse motor, 110 volt, 60 cycle, A.C. plug and cord, safety valve, 15 ft. air hose. Just plug into light socket and it is ready for operation. \$14.50 complete. Send \$5.00 deposit. Invoice C. O. D. Shipping weight, 30 lbs. Sold on money-back guarantee basis.

**WELLWORTH TRADING COMPANY**  
560 W. Washington Blvd., Dept. RC-1235, Chicago, Ill.

### CLASSIFIED ADVERTISEMENTS

Advertisements in this section are inserted at the cost of twelve cents per word for each insertion—name, initials and address each count as one word. Cash should accompany all classified advertisements unless placed by a recognized advertising agency. No less than ten words are accepted. Advertising for the January, 1936, issue should be received not later than November 5th.

**A.C. AUTO GENERATORS**

TWENTY NEW PRACTICAL CHANGES FOR AUTOMOBILE GENERATORS. See our advertisement at bottom of page 367, Auto Power Inc.

**ELECTRICAL SUPPLIES**

INSULATION, WIRE, VARNISHES—COMPLETE line of materials and parts. Send 10c for new, 60-page, white-sale catalog. Autopower, 411-C-S, Home Ave., Chicago.

**RADIO**

RADIO ENGINEERING, BROADCASTING, AVIATION and police radio, servicing, Marine and Morse Telegraph taught thoroughly. All expenses low. Catalog free. Dodge's Institute, Pine Street, Valparaiso, Indiana.

**MAKE SIMPLE LONG DISTANCE POCKET RADIO.** No tubes—no batteries. Reception over hundreds of miles reported. Super-sensitive Melomite crystal and instructions, 25c. Postpaid, Melomite, Dept. PC, Fairmount, Kansas City, Mo.

**TRADE YOUR USED TEST EQUIPMENT ON NEW** latest models Supreme, Triplett, Weston, RCA Oscillograph, etc. Liberal allowance, lowest prices. Lyon-Watt Radio, Wichita, Kansas.

## 80 FEATURES IN THE NEW 18-METAL-TUBE SET!

(Continued from page 345)

heating under continued operation.

No. 20—Insulated screws are used in the power transformer to eliminate core losses.

No. 21—Ventilating louvres pressed in the chassis carry off excess heat.

No. 22—Special core-iron of high-silicon-content minimizes power transformer losses.

No. 23—The entire set is contained on one chassis, eliminating long leads to an auxiliary chassis.

No. 24—The cone of the 12-in. speaker is almost "free-edge" in effect.

### ELECTRICAL FEATURES

- No. 25—The new visual tuning system shows resonance by the dimming of a light.
- No. 26—A continuously-variable A.F. tone control (Fidel-A-Stat) provides (A) normal high-fidelity; (B) low-frequency response only; and, (C) high-frequency response only.
- No. 27—An electrostatic shield between power transformer primary and the secondaries eliminates "clicks," etc., due to power line disturbances.
- No. 28—Weak stations may be found by whistle—Station Finder Button (beat oscillator)—when too weak to operate the tuning light.
- No. 29—A Silencing Button enables all tuning-in to be done in complete silence if desired.
- No. 30—Six full wave bands are provided.
- No. 31—Small variable condensers (under considerable tension) in parallel with large fixed ones prevent drift.
- No. 32—High-inductance plate coils in the R.F. circuits result in highest gain.
- No. 33—Receiver includes 38 tuned circuits.
- No. 34—A pre-installation air test of coil assemblies assures perfect action in the set.
- No. 35—On any band there are always 10 tuned circuits to filter-out unwanted signals.
- No. 36—Only untapped individual and separate coils, wound with wire especially suitable for each frequency range, are used.
- No. 37—Oscillator and set function smoothly over even the 5-meter band, due to the advanced circuits and construction.
- No. 38—A doublet antenna is provided for.
- No. 39—Silver-plated switch contacts assure perfect contact under all conditions.
- No. 40—Moderate set voltages, within the manufacturer's ratings, assure maximum tube life.
- No. 41—The oscillator functions on fundamentals entirely; harmonics are not used.
- No. 42—This is essentially a combination high-grade T.R.F. set and advanced superhet.
- No. 43—By-passing of all circuits is especially complete, as is the circuit shielding, resulting in freedom from parasitic oscillation.
- No. 44—A 24 mf. filter condenser bank, and an extra-heavy filter choke, and speaker-field, result in hum-free operation.
- No. 45—The A.F. system is true push-pull with no trick circuits used for phase inversion.
- No. 46—Low-impedance "B"-supply components insure steady voltage and minimum load drop.
- No. 47—The well engineered and filtered A.F. system grid bias voltages are equivalent to battery bias.
- No. 48—Independent 2nd-detector and A.V.C. functions insure maximum efficiency.
- No. 49—The A.F. driver stage generates considerable power itself, thus adding to the available power output.
- No. 50—Better than 7 kc. selectivity enables weak-station reception through powerful locals.
- No. 51—The A.V.C. action is fully delayed and is applied only to the powerful stations, the very weak ones coming through unrestricted.
- No. 52—Two I.F. stages provide the highest possible usable gain.
- No. 53—The A.V.C. voltage is applied to both the I.F. and R.F. stages, for perfect control.
- No. 54—Amplified or resonant A.V.C. is a design feature in all these sets.
- No. 55—The receiver is designed for a sensitivity of better than 1 microvolt absolute.
- No. 56—Every effort has been made to secure an A.C. load on the diode that equals the D.C. load at all audio frequencies, in order to eliminate harmonic distortion.
- No. 57—An automatically-adjusted low-voltage compensator corrects bass response at low volume levels.
- No. 58—The circuit is designed to handle an antenna input of 0.1-V. without overloading.

## "DEPENDABLE" TUBE TESTER

Combined With **OHMMETER and CONDENSER TESTER, Which Measures ACTUAL CAPACITIES**

Model 305



Ready to Operate, **\$21.95**

Kit, **\$17.85**

**NEW** in principle—new in its multiple usefulness in service work.

In addition to testing all glass and metal tubes, Model 305 is an accurate condenser tester, measuring actual capacities.

Equipped with new-type 5" Bakelite fan-type "Good-Bad" meter in full view of operator and customer. Unique Neon lamp indicates shorts, also leakages above 500,000 ohms.

Handsome black, etched, sloping, metal panel with waterproof case. Counter, portable and deluxe models.

### New POWER LEVEL INDICATOR

An important new service instrument which accurately measures decibels of audio output. Invaluable in checking signal response of receivers and amplifiers. Write Dept. RC-12 for Circular.

**COMPLETE—\$28.75 KIT—\$21.00**

Write Dept. RC-12 for New 1936 Bulletins

**RADIO CITY PRODUCTS CO.**  
88 Park Place, New York, N. Y.

## READ CODE Like an Expert

SEND **CODE** Like an Expert

Learn Quickly at Home—Get Real SPEED

It's easy, fascinating, to become a good op with the Improved MASTER TELEPLEX Code Trencher to help you. Only instrument ever produced which records your sending in visible dots and dashes on copper tapes then sends back to you at any speed you desire. Also sends practice work, recorded by an expert. That is why so many schools teaching code prefer Master Teleplex. That is why thousands agree this method is surest, quickest—has taught more ops in the past few years than all other methods combined. We furnish Complete Course, send you Master Teleplex, give you personal instruction with a MONEY-BACK GUARANTEE. Low cost. Send today for booklet "A36": no obligation; post card will do.



**FREE BOOK**

**TELEPLEX COMPANY**  
76 Corland St., New York, N.Y.

**MASTER TELEPLEX—"The Choice of Those Who Know"**

Please Say That You Saw It in RADIO-CRAFT

# CHEKATUBE C III NEW

INTRODUCTORY OFFER  
READY TO USE TESTS METAL TUBES **\$16.95**  
f.o.b. Factory

and all others without adapters. Use this newly engineered tester for

**10 DAYS FREE**

trial and compare with testers selling for \$35 or more. Impressive, highest quality—has everything—large jeweled meter for line volts and GOOD/POOR tube value. Portable case 10x11x6. Wt. 10 lbs. Tests neon shorts all elements with hot filament. Very simple to operate—only three set ups for any tube like dialing 1-2-3. Order today cash or \$2 balance on delivery.

Established 1922 **J-M-P Manufacturing Co., Inc.**  
3036 N. 34th St. Milwaukee, Wisc.

## PHILA.'S SHORT WAVE HEADQUARTERS

We carry a complete line of parts for all the new short wave circuits appearing in this magazine and other periodicals.

— IN STOCK —

New Patterson PR-16	All Star Jr. & Sr.
National HRO	Browning 35
Sargent Marine	Hammarlund
All Wave Model	Thorndarson
New Silver	Triplett & Dayrad
9 to 200 meter super.	Service Instruments

**M & H Sporting Goods Co.**  
512 MARKET ST. PHILADELPHIA

## WHEN CHOOSING A RADIO SCHOOL



RCA Institutes, with its reputation established by 26 years service, is an institution recognized as an important factor in the radio industry. Whether elementary radio principles or advanced subjects, sound applications or practical radio engineering, RCA Institutes is prepared to give you the instruction you need.

**RESIDENT SCHOOLS NEW YORK AND CHICAGO**  
with modern standard equipment  
**EXTENSION COURSES FOR HOME STUDY**  
under convenient "no obligation" plan  
Illustrated Catalog on Request.

**R. C. A. INSTITUTES, Inc.** Dept. RT-35  
76 Varick St., New York—1154 Merchandise Mart, Chicago

## YOUR OBSOLETE ANALYZER "PRECISION" MODERNIZED

INTO A TWO METER MASTER  
ROTARY SELECTIVE SYSTEM

Write for our Plan  
Mention Model Number of  
Your Old Analyzer

**PRECISION APPARATUS CORP.**

Modernization Division Dept. C

521 E. N. Y. Avenue : Brooklyn, N. Y.

If you are in need of any of the GERNSBACK OFFICIAL RADIO SERVICE MANUALS, we suggest that you turn to page 324B of this issue—there you will find complete details about all the manuals.

## 80 FEATURES IN THE NEW 18-METAL-TUBE SET

(Continued from page 379)

### GENERAL FEATURES

No. 59—Ultra-wide continuous tuning range of 2,400 to 4.5 meters.

No. 60—The 2,400 meter band permits orders and weather reports to be heard.

No. 61—The first commercial all-wave home receiver to tune to 5 meters and less.

No. 62—Tuning ratios of 4-to-1 and 20-to-1 provide correct tuning speeds.

No. 63—To facilitate reference, bands are calibrated in megacycles and meters.

No. 64—To simplify tuning, call letters of well-known stations appear on the dial.

No. 65—Illumination of the call letters aids in locating them quickly.

No. 66—Illumination of metric calibrations speeds locating of short-wave stations.

No. 67—By placing each switch inside its respective R.F. coil shield, high gain and stable performance are secured.

No. 68—Tuning dead spots due to absorption are eliminated by proper positioning of oscillator components with respect to unused coils.

No. 69—Set is constructed in accordance with American Underwriters Assoc. specifications.

No. 70—Circuit and components are designed for low current consumption (low operating cost).

No. 71—Self-healing condensers afford increased life and safety factors.

No. 72—Waterproof compounds seal insulating materials, and entrance points for moisture.

No. 73—Operation in the Tropics is enhanced by the weatherproofing of fine wires and the electrolytic condensers.

No. 74—Large-size shield cans are used to secure maximum I.F. coil efficiency.

No. 75—Factory pre-aging processes stabilize I.F. transformer alignments.

No. 76—Parallel push-pull triodes in class A afford high-quality A.F. output.

No. 77—The oversize dynamic reproducer has been designed for high air-gap flux density.

No. 78—Designed to deliver an A.F. power output of 20 W. without appreciable distortion.

No. 79—Entire receiver has been designed for minimum noise level.

No. 80—Each of the 18 metal tubes has been selected solely for its performance value in a given portion of the circuit, without regard to multi-purpose operation as a means of reducing production cost.

## HOW THE 6E5 CATHODE RAY TUNING TUBE WORKS

(Continued from page 378)

tion of the cathode designated as k will be of the same potential. Now, electrons are propelled in such a direction as to go from a point of low potential (k) to a point of high potential (T), which means that they are propelled at right-angles to the circles of equal potential shown.

Suppose the ray-control electrode E be placed within this field and further suppose that no signal is tuned-in, the electrode will then be at a potential of 50 V. as indicated in Fig. 2B. The electric field of this new electrode disturbs the original field and causes the lines of equal potential to be distorted, as shown. Since the electrons tend to travel at right-angles to lines of equal potential, those which originally traveled straight downward are directed sidewise with the result that no electrons strike sector A-B of the target. This causes no fluorescence in this sector hence a pattern or "shadow" appears on the top of the 6E5 tube as in (A) of Fig. A.

When a station is tuned in to resonance as mentioned previously, the potential of the ray-control electrode, E, increases to approximately full voltage. The electric field is such as to cause electrons to hit all parts of the target except a very small area which approaches a fine line in size. This small area or sector, A-B in Fig. 2C, is caused by the fact that the ray-control electrode E is in the way of the electrons. The result of the tuning-in operation is to cause more of the target to fluoresce, hence a much smaller pattern or shadow appears on the top of the 6E5 tube, as in (B) of Fig. A.

(Every technician who has examined this tube has evolved new and novel uses for it other than its original purpose—it will no doubt have a great future.—Editor)

## 1/30 H.P. MOTORS A.C. or D.C.

These motors were manufactured by the General Electric Company and originally intended for use by a large manufacturing company.



Here are the specifications: 1/30 h.p., 4800 R.P.M., Universal A.C. and D.C., 110 volts. Instant reverse. Size: Diameter 3 inch, length 5 inch.

Add 25c for special packing and mailing anywhere in U.S.A. Ship. Wght. 3 lbs.

**\$2.45 Each**

Sold on a money-back guarantee

**WELLWORTH TRADING CO.** Dept. RC-1235  
560 W. Washington St., CHICAGO, ILL.

Enclosed find \$..... for which ship:  
 G. E. Motors @ \$2.70 each (Prepaid in U.S.A.)

Name.....

Address.....

City..... State.....

## - - a new magazine for short-wave fans! SHORT WAVE LISTENER

4,600 Short Wave stations listed

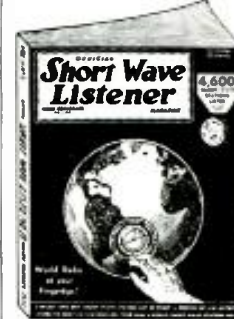

THE finest magazine of its kind ever published—totally different in get-up and contents from any other. Contains the largest listing of short wave stations in the world, up-to-the-minute, in the U.S.A., "Police," "Television," and short-wave stations, as well as a special list of the star short-wave stations with their frequencies and call letters. Also contains photos and descriptions of short-wave broadcasting stations in various parts of the world with photos of short wave studio artists

**25c**

THE COPY

—How to locate "weak" distance stations, and other hints for the "short-wave listener"—Question and Answer Department for the "listener"—Silver Cup Trophy for best photo of listening "Posts."

**SHORT WAVE LISTENER**  
ON ALL NEWSSTANDS 99 Hudson St. New York, N. Y.

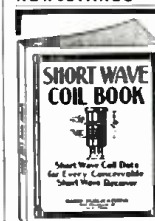

## Every SHORT-WAVE SET-BUILDER NEEDS THIS BOOK

Every experimenter who has ever tried to build a short wave set knows by experience, the difference between a good and a poor receiver is usually found in the short wave coils. Often you have to hunt through magazines, books, etc., to find the information you require. The present book has been gotten up to obviate these difficulties.

In this book you find every possible bit of information on coil winding. Only the most modern "dope" has been published. Illustrations galore, giving not only full instructions on how to wind coils, but dimensions, sizes of wire, curves, how to plot them, by means of which any coil for any particular short wave set can be figured in advance, as to number of turns, size of wire, spacing, etc. There has never been such data published in such easy accessible form as this.

Sent to you upon receipt of

**25c**

in coin or uncanceled U.S. Postage Stamp.

**RADIO PUBLICATIONS,**

101C Hudson St., New York, N. Y.

## MORE \$\$\$\$ FOR YOU

We can show you how to devote spare time to making money for yourself. Simple, easy work—only an hour or two a day, brings you extra dollars. AND, there's no limit to what you can earn. With this extra money you can buy things you want—or save your earnings. There's hundreds of things you can do with a few extra dollars. Everyone in your neighborhood is a prospect—your friends, relatives—all would be interested in what you have to offer. Write to us for your plan "EXTRA MONEY IN YOUR SPARETIME." We'll send you the details promptly. Address: Circulation Manager

**RADIO-CRAFT**

99 Hudson Street New York, N. Y.

Please Say That You Saw It in RADIO-CRAFT



Here are two NEW

10c BOOKS



Each book contains 32 pages—and is well illustrated.

LITERALLY thousands of radio fans have built the famous DOERLE Short Wave Radio Receivers. So insistent has been the demand for these receivers, as well as construction details, that this book has been specially published.

HOW TO MAKE FOUR DOERLE SHORT WAVE SETS

Contains EVERYTHING that has ever been printed on these famous receivers. These are the famous sets that appeared in the following issues of SHORT WAVE 'RAFF': "A 2-Tube Receiver that Reaches the 12,500 Mile Mark," by Walter C. Doerle (Dec., 1931-Jan., 1932); "A 2-Tube Signal Gripper," by Walter C. Doerle (November, 1932); "Doerle 2-Tube Adapted to A C Operation" (July, 1933); "The Doerle 3-Tube Signal-Gripper Electrified," (August, 1933) and "The Doerle Cines Band-Strider" (May, 1934).

HOW TO MAKE THE MOST POPULAR ALL-WAVE 1- and 2-TUBE RECEIVERS

THIS book contains a number of excellent sets, some of which have appeared in past issues of RADIO-CRAFT. These sets are not to be had but have been carefully engineered.

- The Megadyne 1 Tube Pentode Loudspeaker Set, by Huma Gernsbach.
- Electrifying The Megadyne.
- How To Make a 1-Tube Loudspeaker Set, by W. P. Cheney.
- How To Make a Simple 1 Tube All-Wave Electric Set, by W. Green.
- How To Build A Four-In-Two All-Wave Electric Set, by J. T. Bernady, and others.

And believe it or not, each book contains 32 pages and over 15,000 words of new legible type. Each book is thoroughly modern and up-to-date. They are well illustrated. They are not just a reprint of what was printed before. All the latest improvements have been incorporated into the sets.

Remember, these books sell at the extraordinary low price of ten cents each; you can not possibly go wrong in buying them. Despite its low cost, our usual guarantee goes with these books as well—money refunded if not satisfied.



There has never been such a wealth of data published in a low-priced radio book of this type in the history of the radio publishing business.

RADIO PUBLICATIONS  
99 (RC) Hudson Street  
New York, N. Y.

Something NEW!

WEATHER FORECASTER AND HUMIDITY TESTER



"HYGROSCOPE"

The Ace of Weather Forecasters

When placed in a well-ventilated room or in the fresh air, the HYGROSCOPE foretells coming weather conditions from eight to twenty-four hours in advance. It also accurately records outdoor humidity, and when placed inside it gives the humidity within the house or room.

The HYGROSCOPE is automatic self-adjustable, simple American-precision made. It cannot get out of order at any time. The dial measures 2 3/4", is enclosed in a 6" round hardwood case, with either walnut or mahogany finish. It is attractive for desk or living room.

OUTSIDE DIAL FORECASTS WEATHER

Fair—rain—or changeable is indicated on the outer dial when the HYGROSCOPE is placed in a well-ventilated room or out-of-doors. If indoors, place the instrument near an open window.

INNER DIAL SHOWS THE HUMIDITY CONTENT

The HYGROSCOPE also acts as a hygrometer. Numbers on the inner dial indicate the degree of humidity present in the air and in artificially heated rooms.

SEND YOUR ORDER NOW! Get your HYGROSCOPE today. Your remittance in form of check or money order accepted. If you send cash or unused U. S. Postage Stamps, be sure to register your letter. Also specify if you prefer the HYGROSCOPE in Walnut or Mahogany. **\$2.00**

Postpaid

GREN PARK COMPANY

Dept. RC-1235

99 Hudson St. - New York, N. Y.

HOW TO ADD HIGH FIDELITY TO OLD SETS

(Continued from page 347)

These definitions may seem to be too exacting to some "would be" radio manufacturers, but it was necessary to draw this borderline. Every skilled radio technician knows that it is not hard—by means of certain tricks—to obtain an audio-frequency range covering the above borderline from a set of tolerable design.

If the loudness is fluctuating more than 5 db, no one should mark such a set as a high-fidelity receiver, because no real, natural, faithful, reproduction may be obtained if the dynamic relations of the original sounds are changed.

WHAT 5 PER CENT DISTORTION REALLY MEANS

A very important part in the RMA definitions concerning high-fidelity receivers concerns the demand that the total harmonics (distortion) at full-load be less than 5 per cent. In addition, we find there the remark that the electrical output of the receiver should be at least 15 W.

What 5 per cent distortion really means may be seen when, for example, a radio receiver reproduces mainly a 2,000-cycle note—although, in the broadcast studio (in this specific case) only a 1,000-cycle note has been played! In non-technical language it means that, when received on such a set, an alto sounds like a soprano—and a basso, like a baritone!

THE MAIN SOURCE OF DISTORTION

Since it is not hard to obtain a broad A.F. range from 50 to 7,500 cycles by means of an A.F. amplifier equipped with the new high-class audio transformers, nor yet with a well-designed resistance-coupled amplifier (as shown later), attention shall be paid at first to the usual source of distortion, which is in a great many receivers of today—the second-detector. This distortion appears especially if the so-called "square-law" detector with its auxiliaries, the grid-leak and grid-condenser, are used.

Despite this fact the very sensitive square-law detector as shown in Fig. 1 will be used in the future in all cases in which a weak signal is to be picked up with a relatively simple circuit, as for example in short-wave reception. But for high-fidelity reproduction, there is no more use for it.

The reason for this condemnation is due to certain physical conditions which control the function of the square-law detector. We know by hundreds of experiments that the degree of distortion produced by this detector depends upon the degree to which the received radio station is modulated.

The diode detector (see Fig. 3A) really works linearly and only negligible portions of the second-harmonic are produced if the I.F. input is sufficiently high. Since most of the high-fidelity receivers have powerful R.F. and I.F. amplification, the supply of a sufficiently high voltage may easily be solved. However, if the input is low, distortion in the form of the third-harmonic may appear.

In some special cases, for example, if a receiver is to be used for the purpose of re-broadcasting, another type of detector may be used which provides linear detection for both small and large inputs as shown in Fig. 3B. This valuable effect is produced through an additional tube, which makes it possible to obtain a reversed plate current, and having a linear plate voltage curve beyond the reversed-current portion of the characteristic.

For full-wave rectification, the so-called duplex diode (Fig. 4) is to be used. Such a duplex-diode circuit can be theoretically so balanced that no carrier frequency current is supplied to the grid of the following first A.F. tube. Some modern duplex-diode circuits for full-wave detection are shown in Fig. 5.

The other method of detection, the half-wave diode (both plates are connected as shown in Fig. 6), as compared with full-wave detection provides approximately twice the signal output. Since the carrier-frequency filtering can very often be avoided only theoretically by use of the full-wave rectifier, the half-wave type of detector is favored for use in commercial sets today.

TYPES OF AMPLIFIERS

Despite the fact that there are first-class audio transformers available with straight re-

FREE → **RADOLEK DEALERS** make the most **PROFITS**.. Here is the Reason Why!

● The New Radolek 1935 Fall Edition of the Profit Guide is the most complete Radio Parts Catalog ever published—new, bigger and better. Everything in radio—at the right prices. Over 160 pages of valuable, money-saving "radio-buying" information. Over 10,000 separate Repair Parts—hundreds of new items—a complete, new selection of Radio Receivers and Amplifiers. Contains the most complete, exact duplicate, replacement parts listings, of volume controls, condensers, transformers, vibrators ever compiled. Nowhere, ever, has there been a Radio Parts Catalog comparable to this superb book. Every page brings you extra profits. This is your book—it's FREE. If you want the best Radio Parts Catalog—if you want to give better service at bigger profits—then send for this NEW Radolek Profit Guide.

RADOLEK restricts distribution of this catalog to active and legitimate Radio Men. Please enclose your business card or letterhead—

**THE RADOLEK CO.**  
641 West Randolph Street, Chicago, Ill.

Send me FREE the Big New RADOLEK PROFIT GUIDE

Name .....

Address .....

Are you a Serviceman?  Dealer?  Expm?

**RELIABLE AS THE NORTH STAR**

**NEW INSULATED RESISTORS**

*Metallized* **IRC**

The first fully sealed and INSULATED Resistors—ideal and modern for every purpose. Use them anywhere without fear of shorts or opens. Quiet—vibration-proof—moisture-proof. The outstanding resistance development in years!

**INTERNATIONAL RESISTANCE CO.**  
Toronto, Canada Philadelphia, Pa.

**New Book for Radio Men**

Here is a brand new book for Radio men. Full of vital information every beginner or expert should know. Beautifully illustrated—beautifully bound and written, so anyone can understand it.

**"Modern Radio Essentials"**

was written for us by Kenneth A. Hathaway, internationally known Radio authority, and contains an amazing amount of invaluable information for Service Men.

**Sent on Approval**

Send only \$2.00 or less postman upon delivery. If you are not more than satisfied return the book and we will refund every cent you have paid us immediately.

**AMERICAN TECHNICAL SOCIETY**  
Drexel at 58th St., Dept. R926, Chicago, Ill.

Only **\$2.00** Complete

Please Say That You Saw It in RADIO-CRAFT

# "Put It Up"

say customers when you tell them what the RCA World Wide Antenna System will do

When you sell an all-wave receiver, and when you go out on a service call, it is good business to tell the wonderful story of RCA Antenna Systems. These systems, designed by RCA engineers, provide much louder signals, ending complaints about weak foreign reception when due to an inefficient antenna. They also greatly reduce man-made static, including automobile interference, and almost always cure noisy reception. Not difficult to erect, but beyond the skill of the average listener, so you generally get the job. RCA Antenna Systems are available in several forms, complete or in kits of parts, as you prefer. Reasonably priced. Write for booklet, "Antenna Facts".

RCA Parts Division, Dept. RC  
RCA Manufacturing Co., Inc., Camden, N. J.



"I'll Pay a Few Cents More for a SPRAGUE ANY DAY!"



"Remember," writes a successful serviceman, "if filter condensers fail to supply the proper voltage (as many 'bargain' condensers do) nothing about a radio can be wholly right. Other essential parts will work far below their standard of efficiency. The set might play, but never with its greatest volume or best tonal quality.

"I was surprised to find what a whale of a difference Sprague Condensers actually made in pepping up the performance of 'sick' sets. That's why I use 'em on every job. Take it from me, they're cheaper in the long run—and they've helped me build a real reputation for getting better than average results from the average radio set."

Made in a complete line for every radio service and amateur need. Sold by leading jobbers. Write for catalog.

Sprague Products Co., North Adams, Mass.

## SPRAGUE CONDENSERS

Made Right Priced Right



## HOW TO ADD HIGH FIDELITY TO OLD SETS

(Continued from page 381)

sponse curves from 60 to 15,000 cycles, without any fluctuations worth mentioning, and from 20 to 20,000 cycles with fluctuations of only about 2 db. (see Fig. 7), much attention has been paid during recent months to the resistance-coupled audio amplifier. Not only because it is much cheaper, but also because it needs much less space.

### VOLTAGE INVERSION

It is a well-known fact that, for the use of a resistance-coupled push-pull amplifier, inverse voltages are necessary, because one tube of the amplifier stage takes care of one-half cycle of the input signal, and the other one amplifies the remaining half-cycle.

An excellent push-pull amplifier of this type designed by H. L. Shortt is shown in Fig. 8. This amplifier has less than 5 per cent distortion, according to information given by the designer; the output of the amplifier is 15 W.

An interesting method of avoiding the use of two separate inverter tubes has been described recently in an Australian radio magazine. It is known that a single tube, according to Fig. 9, can be used to produce the inverse voltages. The Australian designer was not satisfied with such a circuit and tried a further step in simplification by use of an 85 diode-triode as rectifier and A.F. amplifier with inverted voltages. The circuit of the 85 (see Fig. 10) is a little different in its design, because the usual R.F. choke is replaced by the grid resistor, Rg, and by the 18,000 ohm resistor, Rp, in the plate supply line.

## BOOK REVIEWS

MEASUREMENTS IN RADIO ENGINEERING by Frederick E. Terman. Published by McGraw-Hill Book Co. Size 6 1/4 x 9 1/4 ins., 400 pages, cloth bound. Price \$4.00.

This work is intended for use both by the student and the advanced technician. It contains a comprehensive discussion on the procedure for properly making all types of measurements used in the radio laboratory. In addition 32 experiments are included.

In all cases, the most practical method of making a particular measurement has been presented.

NATIONAL ELECTRICAL CODE HANDBOOK by A. L. Abbott. Published by McGraw-Hill Book Co. Size 5 1/4 x 7 1/2 ins. 523 pages, semi-flexible cloth bound. Price \$3.00.

This book will be invaluable to anyone who works in the electrical field, since it contains under one cover a complete presentation of the scope, plan and intent of the National Electrical Code.

The first 5 pages are devoted to definitions which are used throughout the book. The index is conveniently classified into 5 sections.

TELEVISION AND SHORT WAVE HANDBOOK by F. J. Camm. Published by George Newnes, Ltd., London, England. Size 5 1/2 x 8 ins. 255 pages, cloth bound. Price, 3/6 net.

This book by a well known English author explains in detail the operation of various types of television equipment.

There is a good deal of material on short wave work, and its application to the television field.

Over 50 pages are devoted to a valuable and complete dictionary of television terms.

## Index to Advertisers

<b>A</b>	Aerovox Corporation..... 366	<b>M</b>	M & H Sporting Goods Company..... 380
	Al's Radio Laboratories..... 369		Meissner Mfg. Company..... 356
	Allied Radio Corporation..... 355		Midwest Radio Corporation.....
	Alloy Transformer Corp..... 365		Inside back cover, 377
	American Technical Society..... 381		Midwest Radio Mart..... 356
	Amperite Corporation..... 378		Modern Radio & Television Co..... 369
	Ansley Radio Corp..... 366		The Muter Company..... 358
	Arrow Sales Corporation..... 358	<b>N</b>	National Radio Institute..... 324A
	Atlantic Calendar Company..... 365		National Schools..... 376
	Autonator Laboratories, Inc..... 378		National Union Radio Corp..... 368
	Autopower, Inc..... 367	<b>O</b>	Oxford Radio Company..... 364
<b>B</b>	J. Matheson Bell..... 370	<b>P</b>	The Plan Shop..... 373
	Blan, the Radio Man, Inc..... 365		Powertone Electric Co..... 369
	The Brush Development Company..... 368		Precision Apparatus Corp..... 380
	Burstein-Applebee Company..... 373	<b>R</b>	R-S Merchandising Committee..... 363
<b>C</b>	Capitol Radio Engineering Institute..... 371		Radio & Technical Pub. Co..... 369
	Central Radio Laboratories..... 360		Radio Circular Company..... 365
	H. G. Cisin..... 376		Radio City Products Co..... 379
	Classified Section..... 379		Radio Construction Labs..... 374
	Clough-Brengle Company..... 375		Radio Publications..... 380, 381
	Coast-to-Coast Radio Corp..... 360		Radio Trading Company..... 374, 377
	Consolidated Radio Products Co..... 364		Radio Training Association..... 364
	Continental Carbon, Inc..... 372		Radolek Company..... 381
	Continental Electric Company..... 374		Raytheon Production Corp..... 359
	Cornell-Dubilier Corp..... 371		RCA Institutes, Inc..... 380
	Coyne Electrical School..... 321		RCA Mfg. Co., Inc..... 382
<b>E</b>	Eastern Radio Specialty Co..... 378		Readrite Meter Works..... 365
	Hugh H. Eby, Inc..... 376		Remington Rand, Inc..... 379
	Ellen Radio Laboratories..... 371	<b>S</b>	S. O. S. Corporation..... 373
	Electrad, Inc..... 363		Sears, Roebuck & Company..... 372
<b>F</b>	Freed Radio Company..... 376		Shallerross Mfg. Company..... 362
<b>G</b>	General Cement Mfg. Co..... 365		Solor Mfg. Company..... 377
	General Electric Company..... Back cover		Sprague Products Company..... 382
	General Transformer Corp..... 371		F. L. Sprayberry..... 362
	Globe Apparatus Company..... 370		Standard Transformer Corp..... 367
	Goldentone Radio Company..... 360, 373		Supreme Instruments Corp.....
	Grenpark Company..... 380		Inside front cover
<b>H</b>	Hammarlund Mfg. Company..... 375	<b>T</b>	Tefft Radio Company..... 373
	Hygrade-Sylvania Corp..... 373		Teleplex Company..... 379
<b>I</b>	Insuline Corporation of America..... 373		Thor Radio Company..... 358
	International Correspondence Schools..... 378		Toledo Sound Equipment Labs..... 370
	International Resistance Co..... 381		Triplet Elec. Instrument Co..... 323
<b>J</b>	J M P Mfg. Company..... 380		Triumph Mfg. Company..... 361
<b>K</b>	Kato Engineering Company..... 365		Try Mo Radio Company, Inc..... 374
	The Ken-Rad Corporation..... 367	<b>V</b>	D. L. VanLeuven..... 369
<b>L</b>	Lincoln Engineering School..... 369	<b>W</b>	Wellworth Trading Co..... 375, 377, 379, 380
	Arthur H. Lynch, Inc..... 365		Wholesale Radio Service Co., Inc..... 357
			Wright-DeOoster, Inc..... 366

Please Say That You Saw It in RADIO-CRAFT

KABLE BROS. CO., PRINTERS

SAVE UP TO 50% by BUYING YOUR RADIO *Direct from* MIDWEST LABORATORIES

*Glorious Tone Realism.. World-Wide Entertainment Guaranteed!*  
with New 1936 SUPER *Deluxe*

# METAL TUBE MIDWEST

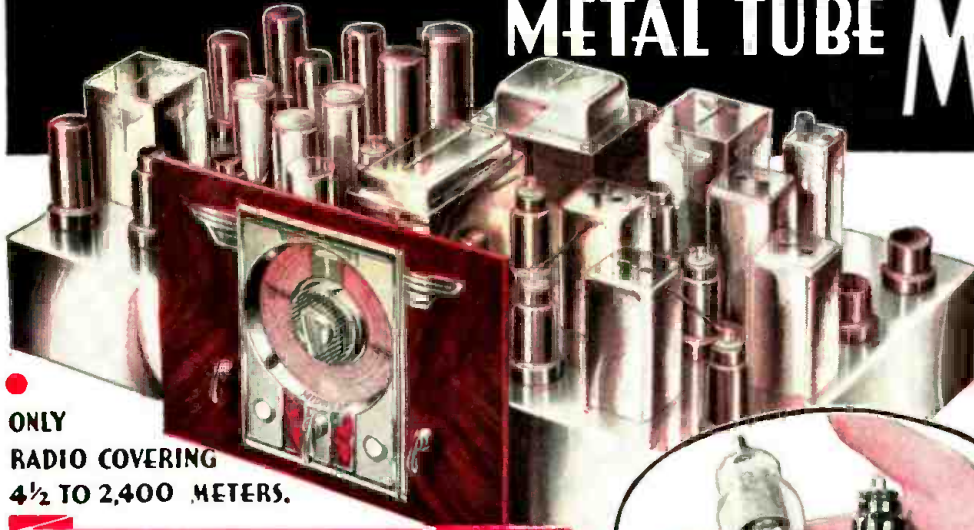

● ONLY RADIO COVERING 4½ TO 2,400 METERS.

# 18 TUBE RADIOS

6 TUNING RANGES

**30 Days FREE Trial!**



WORLD'S GREATEST RADIO VALUE

**\$59.50** with New GIANT THEATRE-SONIC SPEAKER  
(LESS TUBES)

TERMS AS LOW AS \$5.00 DOWN



**PUSH-BUTTON TUNING**  
(Noises Suppressed)

Now, Push Button Silent Tuning is offered for first time! Simply pushing Silencer Button hushes set between stations . . . suppresses noises. Pressing Station Finder Button automatically indicates proper dial position for bringing in extremely weak stations.

**Acousti-Tone V-Spread Design**  
(Patent Pending)

Establishes new radio style overnight! The V-Front Dispersing Vanes were developed by Midwest engineers as a result of a study of directional effect of the Midwest Full Scope High Fidelity Speaker. These Vanes spread the beautiful lacework of the "highs" throughout the entire room in a scientific manner . . . directing the High Fidelity waves uniformly to the ear. Send for new FREE 40-page catalog. It pictures the complete line of beautiful 1936 Acousti-Tone V-Spread consoles . . . and chassis . . . in four colors.

**FULL SCOPE HIGH FIDELITY**  
Brilliant



**Concert Tone**  
Now, get complete range of audible frequencies from 30 to 16,000 cycles, being transmitted by four new High Fidelity Broadcasting stations—WIXBS, W9XBY, W2XR and W6XAL. Glorious new Acousti-Tone is achieved assuring life-like, crystal-clear "concert" realism.

**V-FRONT**

EVERYWHERE, radio enthusiasts are praising this amazingly beautiful, bigger, better, more powerful, super selective, 18-tube 6-tuning range radio. They say it is a tremendous improvement over Midwest's 16-tube set, so popular last season. It is sold direct to you from Midwest Laboratories at a positive saving of 30% to 50%. (This statement has been verified by a Certified Public Accountant who conducted an impartial survey among representative Ohio, Kentucky and Indiana radio retailers.) Before you buy any radio, write for FREE 40-page 1936 catalog. Never before so much radio for so little money. Why pay more? You are triple-protected with: One Year Guarantee, Foreign Reception Guarantee and Money-Back Guarantees! This super Midwest will out-perform \$200 to \$300 sets on a point-for-point comparison. That is why nationally known orchestra leaders like Fred Waring, George Olsen, Jack Denny, Ted Fio Rito, and others use Midwest sets to study types of harmony and rhythmic beats followed by leading American and Foreign orchestras.

**80 ADVANCED 1936 FEATURES**

Scores of marvelous features, many exclusive, explain Midwest super performance and thrilling world-wide all-wave reception . . . enable Midwest to bring in weak distant foreign stations, with full loud speaker volume, on channels adjacent to locals. Only Midwest offers so many features . . . only Midwest tunes as low as 4½ meters . . . only Midwest gives the sensational new Push-Button Tuning feature, etc. See pages 12 to 21 in FREE catalog for description of the 80 features. Read about advantages of 6 Tuning ranges . . . offered for first time: E, A, L, M, H and U. They make this Super De Luxe 18-tube set the equivalent of six different radios . . . offer tuning ranges not obtainable in other radios at any price!

**DEAL DIRECT WITH LABORATORIES**

No middlemen's profits to pay — you buy at wholesale price direct from laboratories . . . saving 30% to 50%. Increasing costs

are sure to result in higher radio prices soon. Buy before the big advance . . . NOW . . . while you can take advantage of Midwest's sensational values. You can order your Midwest 1936 Full Scope High Fidelity Acousti-Tone radio from the 40-page catalog with as much certainty of satisfaction as if you were to come yourself to our great radio laboratories. You save 30% to 50% . . . you get 30 days FREE trial . . . as little as \$5.00 puts a Midwest radio in your home . . . Satisfaction guaranteed or money back. Write today, for FREE catalog.

**SAVE UP TO 50%**



**GEORGE OLSEN PRAISES LIFE-LIKE TONE REALISM**

Long Island, N. Y.—After comparing many different makes, I finally decided upon Midwest. It out-performs other radios costing almost twice as much. The crystal-clear tone is so life-like that it sounds as though I am in the studios, actually hearing artists performing.



**TODAY'S FINEST RADIO SAYS TED FIO RITO**

My new Midwest is finest radio I have had pleasure of hearing. Bass-Treble control is marvelous . . . enables one to hear every instrument in orchestra.



**METAL TUBES**

This Midwest is engineered from the ground up to see either the new METAL tubes or glass-metal counterpart tubes. Octal sockets and newest circuits permit use of either type . . . just as you desire.

**MAIL COUPON TODAY! FOR FREE 30-DAY TRIAL OFFER and 40-PAGE FOUR-COLOR FREE CATALOG**

MIDWEST RADIO CORP.  
Dept. 12F, Cincinnati, Ohio

Without obligation on my part, send me your new FREE catalog, complete details of your liberal 30-day FREE trial offer, and FREE Miniature Rotating 18-tube Dial. This is NOT an order.

User-Agents Make Easy Extra Money

Check Here for details

Name \_\_\_\_\_  
Address \_\_\_\_\_  
Town \_\_\_\_\_ State \_\_\_\_\_  
 Check here, if interested in a Midwest All-Wave Battery Radio

**MIDWEST RADIO CORP.**

DEPT. 12F CINCINNATI, OHIO U.S.A.

Established 1920 Cable Address MIRACO All Codes

GENERAL  ELECTRIC

# Sentry Box Control

*T*

HE SENTRY BOX unit includes the tuning condenser and dial mechanism as well as the coils and switch compartments. Separate coils are used for each circuit and no tapped coils are used. A unique type of construction permits shortest possible leads — coils are mounted directly on their respective band change switches. Separate shielded compartments house the R.F., detector and oscillator circuits. The result is efficiency and stability in performance heretofore impossible of attainment.

Permanence of circuit alignment is assured by the use of the PERMALINER trimmer capacitor — a new air-dielectric trimmer, sealed against moisture and dirt.



A cut-away view of the underside of SENTRY BOX showing coil mountings and PERMALINERS. Note the clean wiring and short, rigid leads.

MODEL A-82. A production broadcast receiver, yet built like a commercial communications instrument. Eight Metal Tubes • Four Reception Bands • Sentry Box • Permaliners • Stabilized Dynamic Speaker • Sliding-rule Tuning Scale • Lo-note Compensation • CW Oscillator may be added.

**\$94.50**

(Eastern List Price)

GENERAL  ELECTRIC

*Radio*